



**NETWORK
TECHNOLOGIES
INCORPORATED**

1275 Danner Dr Tel:330-562-7070
Aurora, OH 44202 Fax:330-562-1999
www.networktechinc.com

RACKMUX® Series

RACKMUX-T15

Rack Mount ANSI Terminal Drawer Installation and Operation Manual



Front and Rear View of RACKMUX-T15-N

TRADEMARK

RACKMUX is a registered trademark of Network Technologies Inc in the U.S. and other countries

COPYRIGHT

Copyright © 2004, 2008 by Network Technologies Inc. All rights reserved. No part of this publication may be reproduced, stored in a retrieval system, or transmitted, in any form or by any means, electronic, mechanical, photocopying, recording, or otherwise, without the prior written consent of Network Technologies Inc, 1275 Danner Drive, Aurora, Ohio 44202.

CHANGES

The material in this guide is for information only and is subject to change without notice. Network Technologies Inc reserves the right to make changes in the product design without reservation and without notification to its users.

TABLE OF CONTENTS

Introduction.....	1
Materials.....	2
Features and Functions.....	3
1. Installation.....	4
1.1 Rack Mounting Instructions.....	4
1.1.1 Standard Rack.....	4
1.1.2 Optional Telco 2-Post Mounting.....	5
1.2 Connect The Cables.....	6
1.3 Power Up The Terminal.....	7
2. Using The RACKMUX.....	7
2.1 How To Setup The Terminal.....	7
2.1.1 Entering Setup.....	7
2.1.2 Saving and Exiting Setup.....	7
2.1.3 Setup Directory.....	7
2.1.4 Default Configuration.....	8
2.2 Changing The Operating Parameters.....	9
3. Local Keyboard Commands.....	16
4. Connector Pin Assignment.....	17
5. Command Guide.....	18
5.1 Commands Supported in ASCII Personalities.....	18
5.2 Variable Values for Table 10 Commands.....	25
6. ANSI Command Guide.....	29
6.1 VT100, VT220 and Console ANSI Command Guide.....	29
6.2 VT52 Command Guide.....	36
7. Using Printer Server in Ethernet Terminal.....	37
Introduction.....	37
7.1 Basic Setup.....	37
7.2 Setup for LPD.....	37
7.3 LPD printing.....	38
7.4 Setup for TFTP.....	39
7.5 TFTP Printing.....	39
8. On-Screen Display (OSD).....	40
8.1 Standard Controls.....	40
8.2 OSD Control Menu.....	40
8.2.1 OSD Main Menu.....	40
8.2.2 Brightness/Contrast Menu.....	41
8.2.3 Color Menu.....	41
8.2.4 Position Menu.....	41
8.2.5 Setup Menu.....	42
9. Keyboard Functions.....	43
9.1 Function Key Operation.....	43
9.2 Number Pad.....	44
9.3 Other Uses of the Function Key.....	45
9.4 Numeric Keypad Option.....	45
10. CPU-to-RACKMUX Ethernet Crossover Cable.....	46
11. DC Power Option.....	47
Dimensional Drawings.....	48
Frequently Asked Questions.....	49
Technical Specifications.....	50
Troubleshooting.....	51
Index.....	51
Warranty Information.....	51

TABLE OF FIGURES

Figure 1- Mount RACKMUX to rack	4
Figure 2- Position RACKMUX with clearance to open	4
Figure 3- Mount to Telco post with optional mounting brackets	5
Figure 4 -Connect a CPU to the RACKMUX	6
Figure 5- Connect to CPU using Ethernet cable	6
Figure 6- Function keys to press for submenus	7
Figure 7- OSD Controls	40
Figure 8- US (English) Keyboard Layout	43
Figure 9- Keyboard LED Indications	43
Figure 10- Keys of the Number Pad	44
Figure 11- Additional multi-function keys	45
Figure 12- U.S. (English) keyboard with numeric keypad	45
Figure 13- U.K. (English) keyboard with numeric keypad	46
Figure 14- German keyboard with numeric keypad	46
Figure 15- RACKMUX with DC Power option	47
Figure 16- Apply wires to terminal block	47

LIST OF TABLES

Table 1- Main Setup Menu Exit Functions	7
Table 2- Programmable Keys	12
Table 3- Color Setup Menu	13
Table 4- Color Palettes	14
Table 5- Local Keyboard Commands in Native Mode	16
Table 6- Serial Port (Serial 1) Connector Pin Assignments	17
Table 7- Serial Port (Serial 2) Connector Pin Assignments	17
Table 8- Printer Port Connector Pin Assignments	17
Table 9- 10Base T Connector Pin Assignments	17
Table 10- Commands Supported in ASCII Personalities	18
Table 11- VT52 Mode Escape Sequences	36
Table 12- Number Pad Keys	44

INTRODUCTION

The RACKMUX-T15 (formerly referred to as RACKMUX-TERMINAL) Rack Mount ANSI Terminal Drawer (RACKMUX) places a VTxx/ANSI Terminal right in the rack for space-saving, convenient control of SUN or PC-based headless servers. This LCD monitor terminal drawer eliminates the need for an external laptop or table-top dumb terminal. This flexible terminal is easy to install and configure for either of the following communication modes:

RS232 Terminal (using a RS-232 port for serial console connection). Use this configuration of the RACKMUX with the NTI SERIMUX™ Console Serial Port Switch to control multiple servers.

Telnet Terminal (using an RJ45 10Base-T network port for Ethernet telnet console connection). The Ethernet connection can be used with any 10Mb-compatible Ethernet host adapter, but is most suited for use with RSC (Remote System Control) Ethernet ports, since these provide the same functionality as serial (ttya) console ports. This connection supports up to 12 telnet sessions to different servers. The state of each server session is preserved by the terminal. Terminal sessions can be switched via hot-keys. When using the Ethernet telnet connection, the Terminal Drawer can be connected to multiple servers via an Ethernet switch. However, it is advisable that the network used to connect the server consoles remains private for security reasons.

Note: Both RS232 serial and Ethernet telnet connections cannot be active at the same time.

This general purpose character terminal drawer offers full transaction capabilities and is largely pre-configured for most applications. It was designed in conjunction with SUN Microsystems to ensure flawless compatibility with all SUN servers. It is also compatible with most racks, including the Sun StorEdge 72", Sun Fire rack, and most EIA 19" racks. This console drawer is the ideal solution for controlling web servers, DNS servers, mail servers and other equipment that lack video card capability, such as the SUN Netra systems and HP servers.

The RACKMUX Terminal drawer is also available with an integrated console switch (RACKMUX-T15-RS16 or RACKMUX-T15-SS8). See our website for details.

Features

- Entire unit is only 1U (1.75") high
- High-quality metal construction (ideal for most industrial and commercial settings)
- 15" TFT Rack Mount flip-up LCD Monitor features a wide viewing angle
- Screen size: 80x24 characters plus status line
- Keyboard lock prevents unauthorized use
- Auto shut-off switch: turns OFF power to the monitor when the LCD is folded closed
- Display format of 800x600
- LCD Display controls (using on-screen menu)
- 83-key (US) or 84-key (UK, German, French, Italian, Spanish) keyboard with wrist pad
- Supports RSC capabilities
- Serial and parallel slave-printer ports
- Includes rack mount kit suitable for SUN and most EIA 19" racks (fits 22" to 39" rack depths via adjustable mounting brackets)
- Optional support for mounting in a two-post Telco rack
- Optional protective anti-glare, tempered glass shield
- Internally mounted AC power supply or optional 48VDC power input
- Locking rails to prevent movement of the drawer when fully extended

Multiple RS-232 Emulations:

- | | |
|----------------|----------|
| • ADDS A2 | • VT100 |
| • PC TERM | • VT220 |
| • PCG Alpha | • WY-50+ |
| • Console ANSI | • WY-60 |
| • TVI910+ | • WY-100 |
| • TV1925 | • WY-120 |
| • VT52 | • WY-325 |

Compatibility

- Compatible with any SUN or PC-based headless server.
- Communicates with routers, bridges, firewalls, and hubs

Options

- LCD anti-glare protective glass shield - add a "G" to the model when ordering (i.e. RACKMUX-T15**G**)
- Telco 2-post style mounting kit- order RL-T15-TEL
- DC Power option- for use with 36-72VDC input- add "48V" to the part number (i.e. RACKMUX-T15**48V**)
- Numeric keypad option- for a separate 17-key numeric keypad, add "-N" to the part number (i.e. RACKMUX-T15-**N**)

See our catalog, visit our website at <http://www.networktechinc.com>, or contact an NTI sales representative at 800-742-8324 (800-RGB-TECH) or 330-562-7070 for more details.

MATERIALS

Materials Supplied with this kit:

- NTI RACKMUX-T15 Rack Mount ANSI Terminal Drawer
- 9DF25DM-NUL-6 6 foot DB9 female to DB25 male null modem cable
- IEC Power Cord, country specific
- 2 Keys for Lock
- 2 Rear Mounting Brackets w/nuts
- 8 #10-32x3/4" screws and cage nuts for mounting to a rack

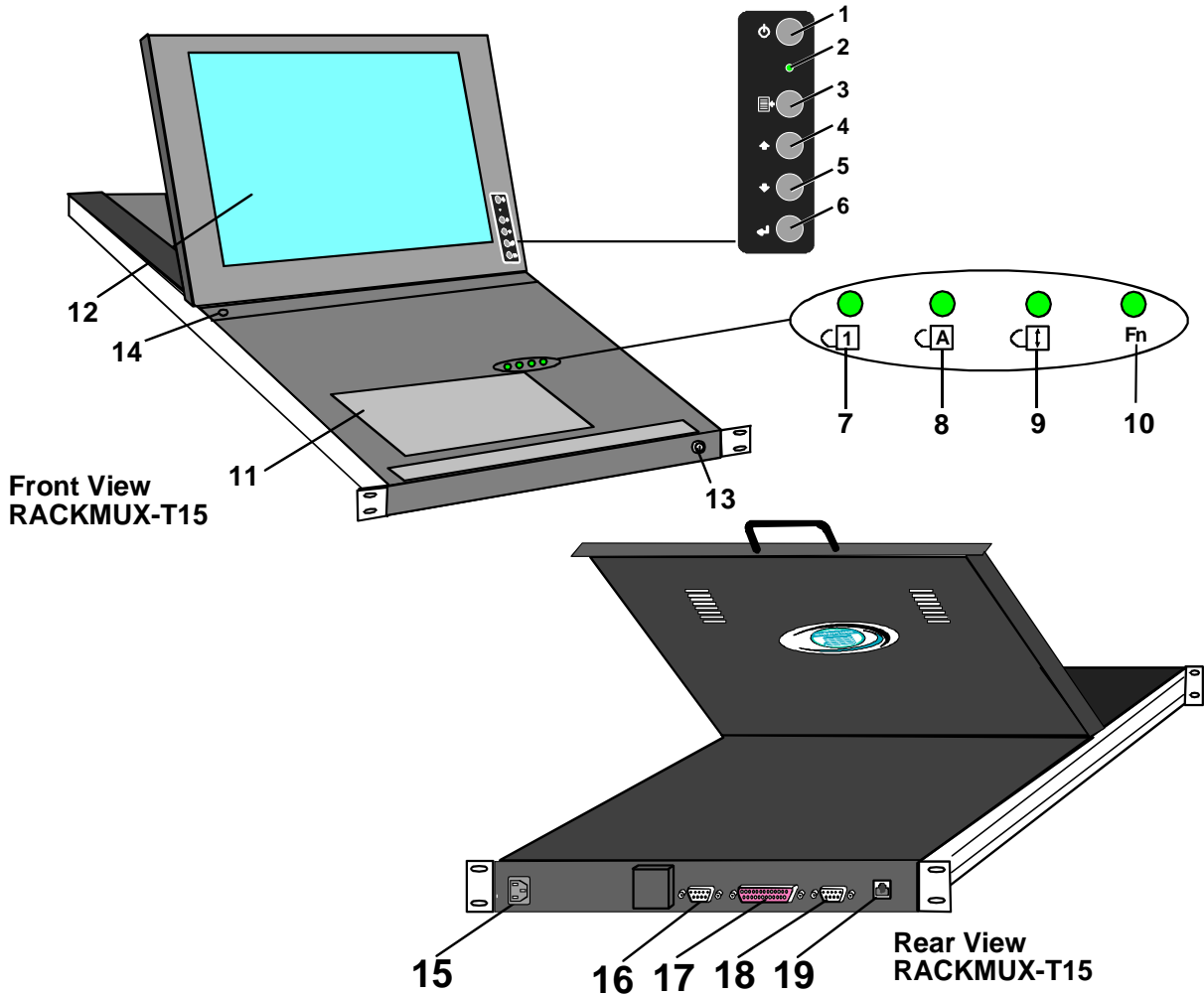

FEATURES AND FUNCTIONS

1. **Power Button-** press to turn the LCD monitor ON and OFF
2. **Power LED-** indicates operation status
Green=Power-On, Video Input Signal OK
Red = Suspend / Stand-by, or no Video Input Signal
3. **Menu Button-** press to turn ON the OSD menu
4. **Up Arrow Button-** press to move the cursor in the OSD menu up
5. **Down Arrow Button-** press to move the cursor in the OSD menu down
6. **Select Button-** press to select a menu item (when OSD menu is ON) or press to auto adjust the video quality (when OSD menu is OFF)
7. **NumLock LED-** illuminates when the number lock is ON
8. **CapsLock LED-** illuminates when CapLock is ON
9. **Scroll Lock LED-** illuminates when ScrollLock is ON
10. **Fn LED-** illuminates when Function Features (page 43) are enabled.
11. **Keyboard-** for manual data entry and computer control
12. **LCD Display-** for viewing the video signal from the connected CPU
13. **Key Lock-** to secure the keyboard in a closed position preventing unauthorized use
14. **Auto Shut OFF Switch-** automatically shuts OFF the LCD display when the monitor is folded down
15. **IEC Connector-** for attachment of the IEC power cord to power the keyboard and mouse
16. **Serial #2-** male SUB D 9 connector- for attaching a local printer serially
17. **Parallel-** female SUB D 25 connector- for attaching local printer with parallel printer cable
18. **Serial #1-** male SUB D 9 connector- for attaching the serial interface cable from CPU
19. **10 Base T-** female RJ45 connector- for connecting 10 Base-T Cat 5 Ethernet cable

1. INSTALLATION

1.1 Rack Mounting Instructions

1.1.1 Standard Rack

The RACKMUX was designed to be mounted to a rack and includes mounting flanges to make attachment easy.

1. Determine the mounting height in the rack for the drawer. It should be a height comfortable to use the keyboard and see the LCD display. Mark holes in each of the 4 corner cabinet rails at points all level with each other.
2. Secure the rear brackets to the rear rack cabinet rails at the holes marked in step 1 using #10-32x3/4" screws and cage nuts (supplied). Be sure to tighten the screws securely.
3. Lift the keyboard into position and line the studs on the left and right sides up with the slotted openings in the rear bracket. Apply the nuts (supplied) to the studs but do not tighten the nuts yet.

FYI: There are 5 mounting studs provided on each side of the RACKMUX. Depending on the depth of the rack and distance apart of the cabinet rails, the position of the rear bracket may make all 5 studs available for use. In this case, apply the 2 nuts to the studs furthest apart from each other on each side.

4. Slide the drawer in until the top holes in the front bracket flanges line up with the holes marked in step 1. Secure the front brackets on the drawer to the front cabinet rails using #10-32x3/4" screws and cage nuts (supplied). Be sure to tighten the screws securely. Then tighten the nuts applied in step 3.

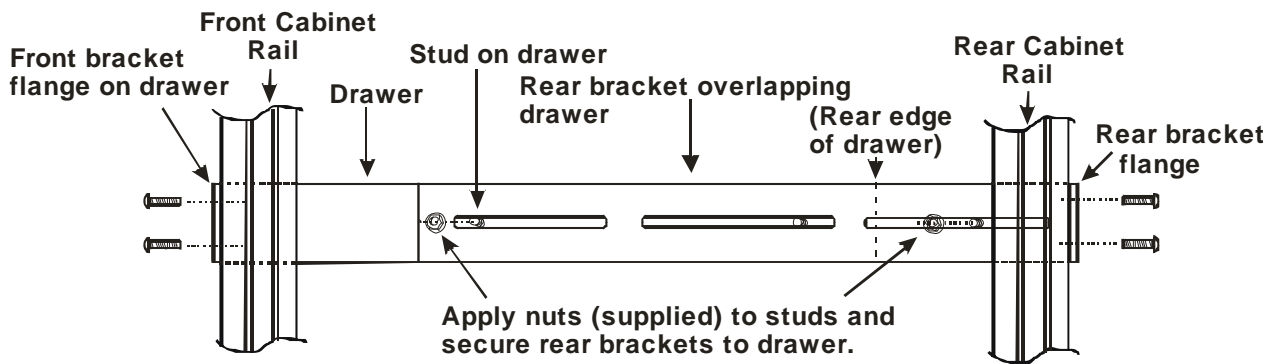

Figure 1- Mount RACKMUX to rack

Note: To provide sufficient room for the LCD monitor to be opened to a proper viewing angle (a minimum 90 degree position from the keyboard), ensure that all devices mounted above the RACKMUX extend no more than 1.75" from the rack frame. (See Fig. 2)

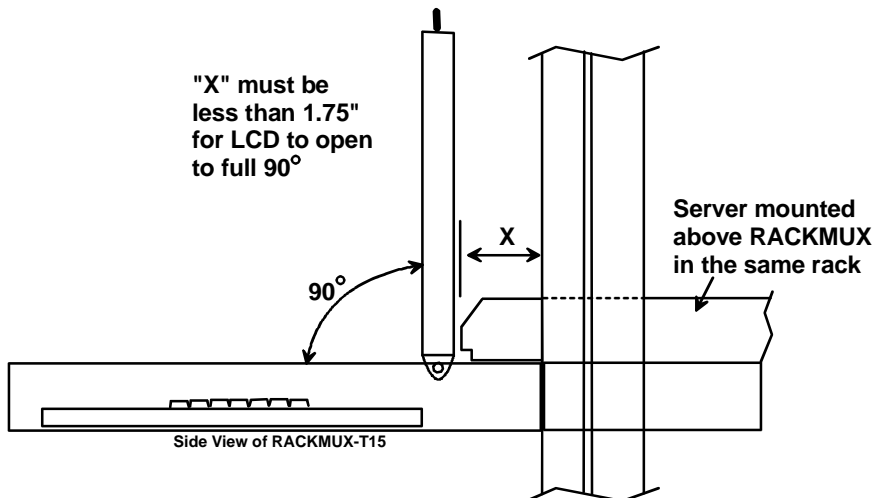
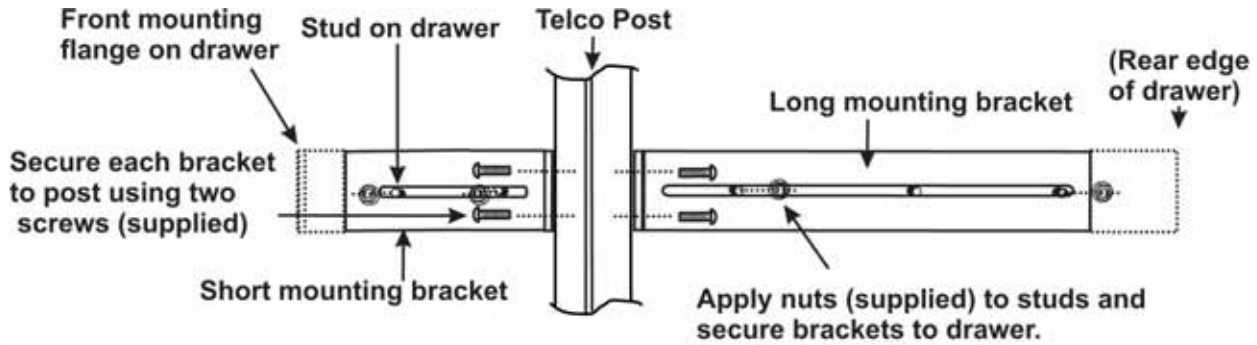

Figure 2- Position RACKMUX with clearance to open

1.1.2 Optional Telco 2-Post Mounting

If the Telco 2-post mounting bracket kit (RL-T15-TEL) is to be used, secure the short and long brackets to each side of the drawer as shown in Fig. 3. Apply 2 nuts (supplied) per bracket to secure the brackets to the drawer. Apply two #10-32x3/4" screws (supplied) per bracket to the post at the desired height. Slots are provided in the brackets to make minor depth adjustments easy. Be sure to properly tighten all nuts and screws before using the drawer.



View of right side of drawer with optional Telco mounting brackets

Figure 3- Mount to Telco post with optional mounting brackets

1.2 Connect The Cables

1. Connect a female SUB D 9 end of the null modem cable (supplied) to the "SERIAL 1" male SUB D 9 serial interface connector on the RACKMUX (see Fig. 4).
2. Connect the other end of the null modem cable to a CPU.

Alternatively, use an Ethernet cable to connect to a CPU (see Fig. 5). For direct connection, use a crossover cable (see pinout on page 46). For connection through a Local Area Network (LAN), use a patch cable wired straight through (pin 1 to pin 1, pin 2 to pin 2, etc.).

Note: A serial cable (Figure 4) and Ethernet cable cannot both be connected at the same time.

3. If connecting a printer, connect either a serial printer cable to the remaining male SUB D 9 connector or a parallel printer cable to the female SUB D 25 connector (see page 3, items 16 & 18).
4. Connect the IEC power cord to the IEC connector.

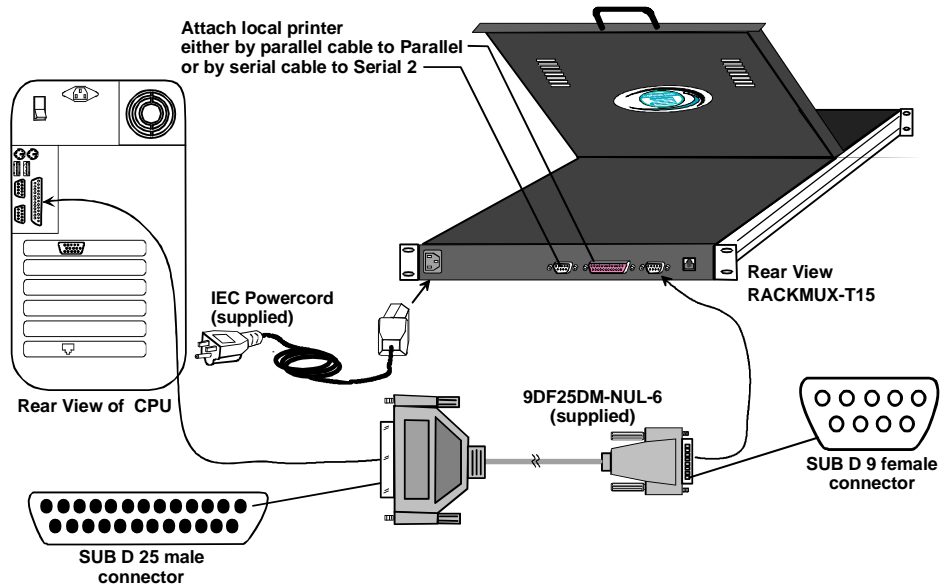

Figure 4 -Connect a CPU to the RACKMUX

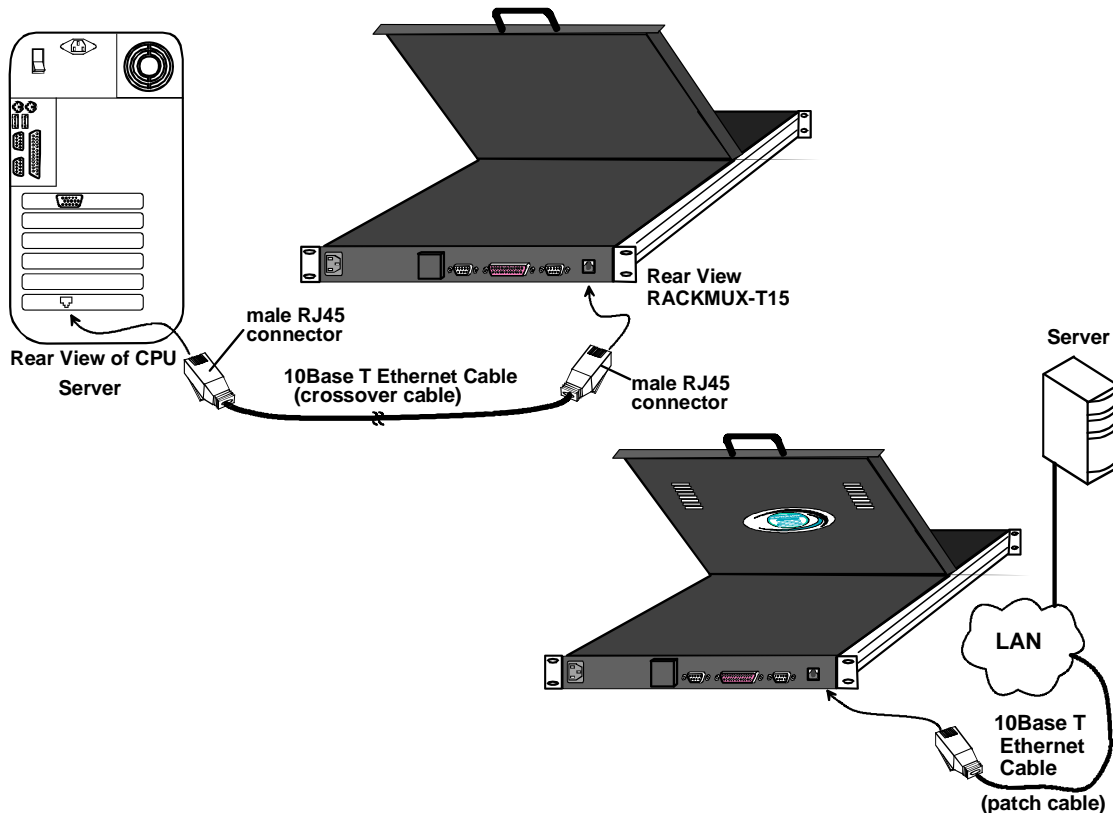

Figure 5- Connect to CPU using Ethernet cable

1.3 Power Up The Terminal

1. Plug in to power ON the RACKMUX.
2. Using the key, unlock the drawer and slide the keyboard and LCD Display out far enough to raise the display to a comfortable viewing angle.
3. Adjust the screen's brightness and contrast with the controls located on the monitor– as needed (see page 40).

2. USING THE RACKMUX

2.1 How To Setup The Terminal

The RACKMUX is compatible with most CPUs and application packages. A menu driven setup system is provided to select and save the settings required by the CPU and application. A user must be familiar with the requirements of the CPU in order to setup the RACKMUX.

2.1.1 Entering Setup

Hold down the <ALT> key and then depress the <Esc> key to enter Setup mode. When entering Setup, any text on the screen temporarily disappears, and the main SETUP directory appears (See Figure 6). When leaving the Setup mode, the main SETUP directory disappears, and any text that was on the screen will reappear.

2.1.2 Saving and Exiting Setup

The first menu seen when entering Setup serves as a directory to the other Setup menus. To exit Setup or any submenu, press <F12>. Pressing <F12> will return the display to the main Setup directory and with another press of <F12> the user will be given the option of saving the selections made.

The highlighted field at the right of the screen gives the user the choice of saving or not saving parameter changes in the memory before returning the terminal to the normal operating mode.

NOTE: If settings are not saved before leaving the Setup mode, any new selections will be lost when the RACKMUX is powered-down.

To save Setup selections, depress the Spacebar to change the save field at the right side of the screen from NO to YES before exiting Setup. (Table 1 describes your options on exiting Setup.)

Depress <F12> to leave Setup and return to the normal display mode.

Table 1- Main Setup Menu Exit Functions

Option	Function
No	Returns terminal to normal operating mode without saving parameter changes for power up
Yes	Saves all changes (operating parameter, tabs, key definition, and answerback message); returns terminal to its normal operating mode.
Shift + Esc	Restores all setting (operating parameters, tabs, key definitions, and answerback message) to default values.

2.1.3 Setup Directory

The fields at the bottom of the screen (Figure 6) show the various setup menus where the terminal's operating parameters can be changed and the function key to press to immediately display any menu.

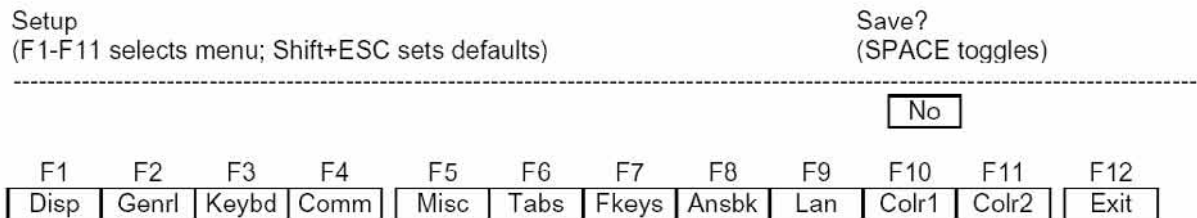

Figure 6- Function keys to press for submenus

2.1.4 Default Configuration

The terminal is delivered pre-configured with the following settings suitable for most RS232 serial console connections at 9600 baud using VT-100 emulation.

<p>Disp SETUP Menu</p> <p>Columns = Econ-80 Cursor = Blink Block Screen Saver = Off Lines = 24 Background = Dark Page Length = 1 x Lines Auto Page = Off Width change clear = Off ANSI Reverse = Off Display= LCD</p>	<p>F2 General SETUP Menu</p> <p>Personality = VT 100 Enhance = On Status Line = Standard Scroll Speed = Jump Auto Scroll = On End of Line Wrap = On Rcvd CR = CR Monitor = Off Attribute = Char</p>	<p>F3 Keybd SETUP Menu</p> <p>Keyclick = Off Key Repeat = 5 Xmt Limit = None Margin Bell = Off Language = US Keycode = ASCII NRC = Off Bell Volume = 2 NUM Start = Off DEL Keypad = Dot/Del</p>
<p>F4 Comm SETUP Menu</p> <p>Baud rate = 9600 Data / Stop Bits = 8/1 Parity = None Rcv Hndshake = Xon/Xoff Xmt Hndshake = Xon/Xoff Comm Mode = FDX XPC Handshake = On Printer Selection = Off Multiple Sessions = Off Ethernet Mode = Off Auto Connect = Off</p>	<p>F5 Misc SETUP Menu</p> <p>Wprt Intensity = Dim Wprt Reverse = Off Wprt Underline = Off Block End = US/CR Ptr Baud rate = 38400 Ptr Data/Stop Bits = 8/1 Ptr Parity = None Ptr Rcv Hndshake = Xon/Xoff Ptr Xmt Hndshake = Xon/Xoff Ptr Rcv = Off</p>	<p>F9 Lan Setup Menu</p> <p>Local IP Address = {blank} Netmask = {blank} Gateway = {blank} Remote IP 0..B Address = {blank} Port 0...B = 23 Term Type = vt100 Ethernet Node ID = (default)</p>

For use with an Ethernet connection the following parameters need to be configured:

- Display Setup (F1 in setup mode)
 - Page Length = 1*Lines (only required if 'Multiple Sessions=On')
- Communications Setup (F4 in setup menu)
 - Multiple Sessions = Off or On
 - Ethernet Mode = On
 - Auto Connect = Off or On
 - 'Multiple Sessions=On' should be set if multiple telnet sessions are required.
 - 'Auto Connect=On' is used to prevent the need to press return to establish a telnet connection.
- LAN Setup (F9 in setup mode)
 - Local IP Address = *IP address of the terminal*
 - Netmask = *Netmask value for the network*
 - Gateway = *gateway address if required by the network*
 - Remote IP 0 Address = *IP address of first server* Port = 23
 - Remote IP 1 Address = *IP address of second server* Port = 23
 -
 - Remote IP B Address = *IP address of twelfth server* Port = 23
 - Term Type = *Same as personality specified in General Setup menu*
 - Ethernet Node ID = *leave at default value*

Note: If only one host is being connected to, all twelve Remote IP addresses and ports should be set to the same value.

Note: Eight separate telnet sessions are allowed if any columns other than Econ-80 is selected in Terminal Display Setup. If Econ-80 is selected, the Multiple Sessions option allows twelve concurrent telnet sessions to be used.

2.2 Changing The Operating Parameters

To select one of the setup menus shown, press the indicated function key.

- The screen for that menu appears with the name highlighted.
- The fields in the middle of the screen indicate the parameters that can be changed in that menu.
- The top line identifies the keys to press to highlight the parameter fields and change the settings.

The procedure is: (1) Use arrow key to highlight the parameter field to be changed.

(2) Use the Spacebar to change the parameter.

<F12> always returns the user to the top menu.

The following tables list the parameters for each menu and explain their settings. Default settings are listed first unless otherwise noted.

F1- Disp SETUP Menu

Columns sets the screen display for 80 columns, 132 columns, or Econ-80 (80 columns with more pages of memory).

Lines sets the screen display for 24, 25, 42, or 43 lines. (24 lines are normally required for VT emulation, 25 lines for PC Term.)

Auto Page on causes a new page of memory to move onto the screen when the cursor reaches the top or bottom of the page.

Display CRT/LCD selects which kind of monitor be used. If LCD monitor is selected, the display columns only support 80 columns on Econ-80 columns. Must be set to LCD.

Cursor sets the cursor display to blink or steady, block or underline.

Background sets the screen display to Dark (light chars. on a dark background) or Light (dark chars. on a light background).

Width Change Clear causes the terminal to clear the screen when executing a command to change the number of columns.

Screen Saver OFF, 1, 2, 3, 4, 5, 6. Sets the screen saver to activate after the specified number of minutes.

Page Length sets the length of a page of display memory to:

- 1 x Lines: Equal to the number of lines selected in the lines parameter (this value must be set when using multiple sessions)
- 2 x Lines: Two times the value of the lines parameter
- 4 x Lines: Four times the value of the lines parameter, or
- *: Equal to the value of the lines parameter, with a second page containing the rest of the lines remaining in memory.

ANSI Reverse OFF/ON. Control function ANSI, VT-100 and VT-220:

- "OFF" means, when SGR command ESC [3? m and ESC [4? m select background and foreground color change respectively.
- "ON" means, when SGR command ESC [3? m and ESC [4? m select foreground and background color change respectively. (? can be 0,1,2,...,7)

F2- Genrl SETUP Menu

Personality sets the terminal's operating mode to Wyse 325, Wyse 120/Wyse 60 (native mode), Wyse 50+ (WY-50, WY-50+, WY-100, ADM 31/5/3a), TeleVideo TVI 925, TVI910+ (includes 910), ADDS A2, Digital Equipment VT-100, VT-220 7 bits, VT-220 8 bits, VT-52, Console ANSI, PC TERM, PCG Alpha.

Scroll Speed sets the display scroll rate to Jump (the rate data is received), Smooth-8 (eight lines per second), Smooth-4, Smooth-2, or Smooth-1.

Rcvd CR causes the cursor to move to the beginning of the current line (CR) or the beginning of the next line (CRLF) when the terminal receives an ASCII CR.

Enhance allows the terminal to recognize an enhanced set of codes when the terminal is not in the native personality.

Auto Scroll causes the data to scroll up a line when the cursor moves past the last line of the page.

Monitor causes the terminal to display symbols for escape sequences and control codes without acting on them (test feature).

Status Line sets the top line of the screen as the status line.

End of Line Wrap causes the cursor to move to the start of the next line when additional characters are entered at the end of a line.

Attribute sets display attributes to be assigned to each character as it is entered (Char), to be active to the end of the line (Line), or to be active to the end of the page (Page).

F3- Keybd SETUP Menu

Keyclick sets the terminal to sound a muted beep each time a key is pressed or repeated.

Margin Bell sets the terminal's bell to ring when the cursor reaches the column where the bell is set (default is column 72 in 80-column mode or 124 in 132-column mode).

NRC ON/OFF determines the communication and keyboard national character set.

DEL Keypad Dot/Del or Comma/Del. Determines whether numlock DEL generates dot or comma.

Key Repeat OFF, 1,, 8. Defines key repeat rate after a key has been depressed for about 1/2 second.

Language sets correct terminal operation for the language of the keyboard connected to it: US, UK, Danish, German, Spanish, Swedish, Norwegian, Italian, French, Belgian, Swiss/French, and Swiss/German. Should be set to US.

Bell Volume OFF, 1, 2, 3 (3 different volumes)

Limit Xmt causes the terminal to send data through the HOST port as fast as the baud rate allows (None), or at a maximum rate of 60 cps or 150 cps. In older systems limiting character rate is necessary to prevent loss of data.

Key Code sets the terminal to send normal ASCII characters (ASCII) or PC-type scan codes for every key up / down (Scan). Scan is only required for the PC Term personality.

Num Start ON/OFF. When the terminal powers ON, this field determines whether the numeric pad starts as Numeric (NUM ON) or Function (NUM OFF).

F4- Comm SETUP Menu

Baud Rate sets the host port baud rate to 50, 110, 134.5, 200, 300, 600, 1200, 2400, 4800, 7200, 9600, 19200, 38400, 57600, 76800, or 115200.

Rcv Hndshake allows the terminal to control the receipt of data from a device connected to the SERIAL1 port with no handshaking (None), Xon / Xoff handshaking, DTR handshaking, DTR / Xoff handshaking

XPC Hndshake ON/OFF to set XPC code handshake, only possible when the personality parameter is set to PC Term.

Ethernet Mode ON/OFF to set the communication routing by Ethernet Network / or Serial Port.

Note: Set to ON when using Telnet and OFF when using serial port communication.

Data / Stop Bits through the SERIAL1 port, the terminal to send and receive 8-bits data with one stop bit or two stop bits, or 7-bits data with one stop or two stops bits.

Xmt Handshake causes the terminal, when sending data to a device connected to the SERIAL1 port, to ignore all incoming software handshaking signals (None) or to control data output in responds to Xon/Xoff handshaking.

Printer

Parallel : sends data to a parallel printer connected to the parallel port.

Serial : sends data to a serial printer connected to the serial 2 port.

OFF : ignores the print command.

Auto Connect OFF/ON selects whether a return character is required to establish an Ethernet connection.

Parity sets the terminal send data to the SERIAL1 (printer) port with none, odd, mark, even, or space parity.

Comm Mode sets the SERIAL1 port communication mode to full duplex (FDX), block (BLK), half duplex (HDX), or half duplex block (HBLK).

Multiple Sessions defines whether an Ethernet connection supports multiple sessions function.

ON : indicates the terminal supports multiple sessions. Each session only has one display page. In 80 or 132 column mode, 8 simultaneous sessions are supported. In Econ-80 column mode, 12 simultaneous sessions are supported.

OFF : indicates the terminal only has single session. In this mode page length greater than one page can be defined.

F5- Misc SETUP Menu

Wprt Intensity sets the write protect attribute: normal, blank, dim, blank/dim.

Block End causes the terminal to send a block of data to the CPU with a line terminator as an ASCII US character and block terminator as an ASCII CR character (US / CR), or with line terminators as ASCII CR and LF characters and the block terminator as an ASCII ETX character (CRLF / ETX).

Ptr Parity causes the terminal to send the data to the SERIAL 2 (printer) port with none, odd, mark, even, or space parity.

Printer RCV ON/OFF

Wprt Reverse sets the write-protected characters to appear in reverse (dark characters on a light background).

Ptr Baud rate sets the SERIAL 2 (printer) port baud rate to 75, 150, 300, 600, 1200, 2400, 4800, 7200, 9600, 19200, 38400, 57600, 76800, 115200, 230400, 460800.

Ptr Rcv Hndshake sets the printer receive handshake through SERIAL 2 to be none, DTR, Xon / Xoff, DTR/Xoff .

Wprt Underline sets the write-protected characters to appear underlined.

Ptr Data/Stop Bits sets the data and stop bits through the SERIAL 2 (printer) port.

Ptr Xmt Hndshake sets the printer handshake to be none, DSR, Xon / Xoff, or Both .

F6-Tabs SET-UP Menu

On the tabs setup menu screen, the terminal's current tab stops are indicated by uppercase T's displayed along a line of periods that mark each column position.

- (1) A tab stop in columns 2 through 78 is shown as a T in the upper line of periods
- (2) A tab stop in columns 79 through 132 is shown as a T in the lower line of periods

The user can easily determine where tabs are set by moving the cursor across the line and reading the column number displayed on the right side of the screen. Clear and set tabs anywhere on the line, as follows:

- (1) To move the cursor across the line, press < → > (right arrow) or < ← > (left arrow)
- (2) To either clear or set (toggle) an individual tab stop at the cursor position, press <Spacebar>
- (3) To clear all tabs, press <Home>
- (4) To set tabs to the default setting (every eighth column), press <Backspace>

Note: A tab stop cannot be set to column 1.

F7- FKeys SET-UP Definition Setup Menu

The function keys and many of the editing keys can be redefined to send a unique character string of up to 64 characters. Keys that are not programmed will send a default sequence, which is determined by the personality selected. Table 2 lists the programmable keys.

To redefine a key:

1. Select the key to be redefined by pressing that key together with <Ctrl> . This highlights the key's definition field.
2. Press <↑ > (up arrow) to select the shifted or unshifted key definition field.
3. Enter the key definition (up to 62 characters) at the cursor position. Correct errors by pressing < ← > (left arrow) to delete characters or <Home> to clear the definition.
4. If the user wants to change the key's direction, press <Enter> (on the numeric pad) until the desired choice appears.

Direction determines where the key data is transmitted:

 - Remote: Sends data to the CPU only, regardless of the terminal's communication mode. (Until redefined, the direction of all the programmable keys is remote.)
 - Local: Sends data to the terminal only, regardless of the terminal's communication mode
 - Normal: Sends data to the CPU and / or the terminal, depending on the terminal's communication mode

Table 2- Programmable Keys

Enhanced PC-Style Keyboard	Enhanced PC-Style Keyboard
F1 through F12	ENTER (Both ENTER keys are programmable)
↑ (UP ARROW)	ESCAPE
↓ (DOWN ARROW)	HOME
← (LEFT ARROW)	INSERT
→ (RIGHT ARROW)	PAGE DOWN
BACKSPACE	PAGE UP
DELETE	PRINT SCREEN
END	TAB

F8- Ansbk SET-UP Menu

A message of up to 20 characters can be programmed to identify the terminal to the CPU. Enter the message at the cursor position. Correct errors by pressing < ← > (left arrow) to delete characters or <Home> to clear the message.

CONCEAL hides the answerback message, so it is not displayed in setup mode.

To save the message in nonvolatile memory, exit Setup mode with the **YES** option.

F9- Lan Setup Menu

This menu configures the terminal for Ethernet communication. Use of Ethernet communications provides the additional ability to open multiple sessions (applications) on one or more CPUs/servers at the same time. Support of these extended features requires the server to be configured to accept telnet connections.

Note: The Ethernet option in the F4 setup menu must be set to ON for the terminal to work in an Ethernet environment.

Local IP Address is the IP address assigned to this terminal. This must be a unique IP address. An example of this address is 200.200.200.10.

Netmask is a value generated by the system based on the IP address. The system administrator would have this information. An example is 255.255.255.0

Gateway This IP address is used to communicate with other networks. If a gateway is not being used this option should be blank.

Remote IP 0..B Address are for any remote CPU, or devices, that the terminal will communicate with for a specific session. These twelve remote IP addresses should all be identical if all communications will be with only one CPU. If Multi-session-ON in the F4 menu has been selected, and there is more than one CPU on the system, the user must specify which CPU each session will communicate with. To communicate with a different CPU for a future session, these settings must be changed.

Note 1: The Multi-session option allows 8 separate sessions if any emulation other than ECON-80 is selected. If ECON-80 emulation is selected, the Multi-session option will then allow 12 separate sessions.

Note 2: Port 23 is the telnet service by default.

Note 3: The terminal must be powered cycled after saving for these parameters to take effect.

Term Type allows definition of the terminal with up to 40 characters. If Term Type is empty the default type is sent to the CPU by the system.

Ethernet Node ID displays the serial number of the hardware Ethernet interface device. This is a default value of the manufacturer of the hardware device and should not be changed.

F10- Colr1 Set-up Menu

Selects the color palette to be used for each screen attribute. A text sample of the selected color is displayed next to each selection. Attribute selections are listed below.

- | | |
|-----------------|-----------------------|
| Normal | Undl. |
| Dim | Undl. Blank |
| Blank | Undl. Blink |
| Blink | Undl. Blink Blank |
| Blink Blank | Undl. Rev |
| Rev | Undl. Rev Blank |
| Rev Blank | Undl. Rev Blink |
| Rev Blink | Undl. Rev Blink Blank |
| Rev Blink Blank | |

F11- Colr2 Set-up Menu

The color functionality differs with emulation. In general VT100, VT220 and ANSI Console work with applications, which control the color directly. The remaining personalities associate colors based on existing monochrome video attributes. This section will define parameter selection based on personality selected.

Background = Will determine the color of the background screen under some conditions (16 colors).

Normal F.G. \ Normal B.G. = These fields allow the user to select the character and background color (16 colors) for data entered on the display before the application defines the color display remotely.

Border Color = The color of the border around the edge of the screen.
Cursor = Will select the color of the cursor (16 colors).

Intensity F.G. \ Intensity B.G. = These fields allow the user to select the character and background color (16 colors) for data entered on the display as Dim in ASCII emulation's and Bold in VT\ANSI emulation's before the application defines the color display remotely.

Attribute = Bold/Blink

Color mode = Is automatically selected based on the emulation selected.

Color map = Applies in WY325 mode only and determines if the monochrome attribute Reverse or Blank will be used to map monochrome attributes to color.

Color Association = OFF/ON

Table 3- Color Setup Menu

Option	ASCII (NOT WY325)	WY325 *	VTXXX	ANSI CONSOLE
Background =	The whole data area of the screen will be displayed in this color, when the application hasn't entered character or spaces with the Normal or Intensity B.G. color. Changes in Background color will affect Normal and Intensity B.G. Any clear screen commands will clear to this color.	No Function	Same as ASCII	Same as ASCII
Cursor =	Selects Cursor color	Selects Cursor color	Selects Cursor color	Selects Cursor color
Normal F.G. =	Selects color of Normal F.G.	No Function	Initial color selection at power up	Initial color selection at power up
Normal B.G. =	Selects color of Normal B.G.	No Function	Initial color selection at power up	Initial color selection at power up
Intensity F.G. =	Selects color of Intensity F.G.	No Function	Initial color selection at power up	Initial color selection at power up
Intensity B.G. =	Selects color of Intensity B.G.	No Function	Initial color selection at power up	Initial color selection at power up
Color Mode = Normal/Palette	Automatic	Automatic	Automatic	Automatic
Color Map =	No Function	See Above	No Function	No Function

* When the WY 325 personality is selected holding the Ctrl key down and depressing either the 0, 1, ..., 9 or (.) period keys in the numeric pad change the assignment of color on the screen. Each selection is called a palette and is described in Table 4.

Table 4- Color Palettes

Palette	Display Attribute	Foreground Color	Background Color
0	Normal	Green	Black
	Reverse (or blank)* ₁	Black	Yellow
	Intensity* ₂	Blue	Black
	Intensity* ₂ and reverse (or blank)* ₁	Black	Blue
	Underline	Cyan	Black
	Underline and reverse(or blank)* ₁	Black	Cyan
	Underline and intensity* ₂ ,* ₃	Red	Black
	Underline, intensity, * ₂ and reverse (or blank)* ₁	Black	Red
1	Normal	Green	Black
	Reverse (or blank)* ₁	Black	Red
	Intensity* ₂	Yellow	Black
	Intensity* ₂ and reverse (or blank)* ₁	Black	Yellow
	Underline	Cyan	Black
	Underline and reverse (or blank)* ₁	Black	Cyan
	Underline and intensity* ₂ ,* ₃	White	Black
	Underline, intensity, * ₂ and reverse (or blank)* ₁	Black	White
2	Normal	Cyan	Black
	Reverse (or blank)* ₁	Black	White
	Intensity* ₂	Red	Black
	Intensity* ₂ and reverse (or blank)* ₁	Black	Red
	Underline	Magenta	Black
	Underline and reverse (or blank)* ₁	Black	Magenta
	Underline and intensity* ₂ ,* ₃	Blue	Black
	Underline, intensity, * ₂ and reverse (or blank)* ₁	Black	Blue
3	Normal	Cyan	Black
	Reverse (or blank)* ₁	Black	Blue
	Intensity* ₂	White	Black
	Intensity* ₂ and reverse (or blank)* ₁	Black	White
	Underline	Magenta	Black
	Underline and reverse (or blank)* ₁	Black	Magenta
	Underline and intensity* ₂ ,* ₃	Yellow	Black
	Underline, intensity, * ₂ and reverse (or blank)* ₁	Black	Yellow
4	Normal	Magenta	Black
	Reverse (or blank)* ₁	Black	Cyan
	Intensity* ₂	Blue	Black
	Intensity* ₂ and reverse (or blank)* ₁	Black	Blue
	Underline	Green	Black
	Underline and reverse (or blank)* ₁	Black	Green
	Underline and intensity* ₂ ,* ₃	Red	Black
	Underline, intensity, * ₂ and reverse (or blank)* ₁	Black	Red
5	Normal	Magenta	Yellow
	Reverse (or blank)* ₁	Black	Black
	Intensity* ₂	White	White
	Intensity* ₂ and reverse (or blank)* ₁	Black	Black
	Underline	Green	Green
	Underline and reverse (or blank)* ₁	Black	Black
	Underline and intensity* ₂ ,* ₃	Cyan	Black
	Underline, intensity, * ₂ and reverse (or blank)* ₁	Black	Cyan

Table 4- Color Palettes (Cont'd)

Palette	Display Attribute	Foreground Color	Background Color
6	Normal	Yellow	Black
	Reverse (or blank)*1	Black	Yellow
	Intensity*2	Red	Black
	Intensity*2 and reverse (or blank)*1	Black	Red
	Underline	Cyan	Black
	Underline and reverse (or blank)*1	Black	Cyan
	Underline and intensity*2,*3	Magenta	Black
	Underline, intensity, *2 and reverse (or blank)*1	Black	Magenta
7	Normal	Red	Black
	Reverse (or blank)*1	Yellow	Red
	Intensity*2	Magenta	Black
	Intensity*2 and reverse (or blank) *1	Black	Magenta
	Underline	Cyan	Black
	Underline and reverse (or blank)*1	Black	Cyan
	Underline and intensity*2,*3	Green	Black
	Underline, intensity, *2 and reverse (or blank) *1	Black	Green
8	Normal	White	Black
	Reverse (or blank)*1	Black	White
	Intensity*2	Red	Black
	Intensity*2 and reverse (or blank)*1	Black	Red
	Underline	Yellow	Black
	Underline and reverse (or blank)*1	Black	Yellow
	Underline and intensity*2,*3	Magenta	Black
	Underline, intensity, *2 and reverse (or blank)*1	Black	Magenta
9	Normal	White	Black
	Reverse (or blank)*1	Black	White
	Intensity*2	Yellow	Black
	Intensity*2 and reverse (or blank)*1	Black	Yellow
	Underline	Blue	Black
	Underline and reverse (or blank)*1	Black	Blue
	Underline and intensity*2,*3	Cyan	Black
	Underline, intensity, *2 and reverse (or blank)*1	Black	Cyan
10 (Soft Palette)	Normal	Green	Black
	(soft Reverse (or blank)*1 palette) Intensity*2	Black	Yellow
	Intensity*2 and reverse (or blank)*1	Blue	Black
	Underline	Black	Blue
	Underline and reverse (or blank)*1	Cyan	Black
	Underline and intensity*2,*3	Black	Cyan
	Underline, intensity, *2 and reverse (or blank)*1	Red	Black
	Underline, intensity, *2 and reverse (or blank)*1	Black	Red

*1. Whether the reverse or blank attribute is mapped to the colors shown depends on an escape sequence or the setting of the Color Map setup parameter on the Attribute menu. The default is *reverse*. When the *blank* attribute is mapped, only the background is visible.

*2. The intensity is *dim* in ASCII personalities and *bold* in ANSI personalities. (The intensity attribute is not supported in the following personalities: Wyse 50+, ADDS A2, TVI 910+, TVI925, and VT52.) The attribute can be disabled by an escape sequence or in setup mode (Intensity Attribute parameter).

*3. In each palette, the status line displays the same foreground and background colors as shown here for the underline-and-intensity attribute.

3. LOCAL KEYBOARD COMMANDS

Table 5 lists local keyboard commands in the terminal's native mode.

Table 5- Local Keyboard Commands in Native Mode

Key Sequence by keyboard Style

Command	Enhanced PC
Toggle CAPS LOCK on/off	CAPS LOCK
Toggle NUM LOCK on/off	NUM LOCK
Put terminal in SETUP mode	ALT ESC
Partially reset terminal, including communication unlock keyboard, turn off all print modes	ALT PAUSE
Send break* ₁	BREAK* ₂
Toggle between block and full-duplex modes	SHIFT BREAK
Print Screen formatted	PRINT SCREEN
Turn auxiliary print mode on/off	SHIFT SYS REQ* ₃
Turn monitor mode on/off	CTRL SHIFT 1 (kpd)
Turn status line display on/off	CTRL
Speed scrolling rate	CTRL SHIFT
Slow scrolling rate	CTRL SHIFT
Home cursor and clear page	CTRL SHIFT HOME
Display page 0	CTRL 0kpd
Display page 1	CTRL 1kpd
Display next page (or active other window) * ₄	PAGE DOWN
Display previous page (or active other window) * ₅	PAGE UP
Toggle between split screen* ₅ and full screen format	CTRL SHIFT -kpd
Toggle Session 0* ₆	ALT F1
Toggle Session 1* ₆	ALT F2
Toggle Session 2* ₆	ALT F3
Toggle Session 3* ₆	ALT F4
Toggle Session 4* ₆	ALT F5
Toggle Session 5* ₆	ALT F6
Toggle Session 6* ₆	ALT F7
Toggle Session 7* ₆	ALT F8
Toggle Session 8* ₆	ALT F9
Toggle Session 9* ₆	ALT F10
Toggle Session A* ₆	ALT F11
Toggle Session B* ₆	ALT F12
Close the active Session by Local Terminal* ₆	CTRL SHIFT. Kpd

*1. To MODEM port only when configured as data port: has no effect on AUX port.

*2. [BREAK] = [PAUSE] pressed together with [CTRL].

*3. [SYS REQ] = [PRINT SCREEN] pressed together with [CTRL].

*4. If screen is split.

*5. Splits screen at line 12.

*6. Only active at Ethernet mode ON.

4. CONNECTOR PIN ASSIGNMENT

**Table 6- Serial Port (Serial 1) Connector Pin Assignments
(RS232C 9-pin connector)**

Pin	Signal	Mnemonic Direction
1	Data carrier detect	DCD In
2	Receive data	RxD In
3	Transmit data	TxD Out
4	Data terminal ready	DTR Out
5	Signal ground	SGND
6	Data set ready	DSR In
7	Request to send	RTS Out
8	Clear to send	CTS In

**Table 7- Serial Port (Serial 2) Connector Pin Assignments
(RS232C 9-pin connector)**

Pin	Signal	Mnemonic Direction
1	Data carrier detect	DCD In
2	Receive data	RxD In
3	Transmit data	TxD Out
4	Data terminal ready	DTR Out
5	Signal ground	SGND
6	Data set ready	DSR In
7	Request to send	RTS Out
8	Clear to send	CTS In

**Table 8- Printer Port Connector Pin Assignments
(Compatible with the IBM PC parallel port)**

Pin	Signal	Mnemonic Direction
1	-Strobe	Out
2	Data bit 0	Out
3	Data bit 1	Out
4	Data bit 2	Out
5	Data bit 3	Out
6	Data bit 4	Out
7	Data bit 5	Out
8	Data bit 6	Out
9	Data bit 7	Out
10	-Acknowledge	In
11	Busy	In
12	Paper end	In
13	Slct	In
14	-Auto feed XT	Out
15	-Error	In
16	-Init	Out
17	-Slctn	Out
18-25	Ground	Out

**Table 9- 10Base T Connector Pin Assignments
(RJ45 8 pin female connector)**

Pin	Signal	Direction
1	Transmit +	Out
2	Transmit -	Out
3	Receive +	In
6	Receive -	In

5. COMMAND GUIDE

5.1 Commands Supported in ASCII Personalities

Table 5-1 lists all the ASCII commands recognized by the terminal. The native mode code for the command is given in the second column. (The native mode includes WY-325, WY-120 and WY-60.) The remaining columns show the support for the command in other ASCII personalities according to the following notations:

Same

Same as native code (code is native to other terminal also)

Wyse

Same as native code (Wyse enhancement- code not native to other terminal)

ENH

Same as native code when enhance mode is ON (Wyse enhancement - code not native to other terminal) A code listed under a nonnative personality indicates that the related terminal's native code is supported.

A blank in any column indicates that the command is not supported.

Variables are shown in italics. Their values are listed in alphabetical order at the end of the table. Footnotes are found at the end of Table 10 on page 20.

Table 10- Commands Supported in ASCII Personalities

FUNCTION	Command				
	Native Mode	Wyse WY-50+	ADDS VP A2	TVI 910+/925	PC Term
Monitor Mode Monitor mode on Monitor mode off	ESC U ESC u or ESC X	Same Same		Same Same	Same Same Same
Selecting Personalities Enhance mode off Enhance mode on Select WY-50+ mode Select TVI 910+ mode Select TVI 925 mode Select ADDS VP A2 mode Select Console ANSI mode Select Native mode Select PC Term mode Select VT52 mode Select VT100 mode Select PCGAPHIC mode ^{*1} Select VT220-7 mode Select VT220-8 mode Select WY-325 mode ^{*3}	ESC ~ SPACE ESC ~ ! ESC ~ " ESC ~ # ESC ~ \$ ESC ~ % ESC ~ A ESC ~ 4 ESC ~ 5 ESC ~ 6 ESC ~ ; ESC ~ ESC ~ < ESC ~ = ESC ~ B	Same Same Same Same Same Same Same Same Same Same Same Same Same Same Same	ENH ENH ENH ENH ENH ENH ENH ENH ENH ENH ENH ENH ENH ENH ENH	ENH ENH Wyse Wyse Wyse Wyse Wyse Wyse Wyse Wyse Wyse Wyse Wyse Wyse Wyse	ESC v SPACE ESC v ! ESC v " ESC v # ESC v \$ ESC v % ESC v A ESC v 4 ESC v 5 ESC v 6 ESC v ; ESC v ESC v < ESC v = ESC v B
Communicating with the computer Enable transmission Stop transmission Disconnect Send ACK (if ACK mode on)	CTRL Q CTRL S CTRL E	Same Same Same	Same Same	Same Same Wyse	Same Same Same

Table 10- Commands Supported in ASCII Personalities (Cont'd)

FUNCTION	Native Mode	Wyse WY-50+	Command ADDS VP A2	TVI 910+/925	PC Term
ACK mode off	ESC e 6	Same		ENH	
ACK mode on	ESC e 7	Same		ENH	
Full-duplex mode on	ESC C ESC D F	Same		Same	ESC }
Half-duplex mode on	ESC C ESC D H	Same		Same	ESC {
Block mode on	ESC B	Same		Same	Same
Block mode off (conversation)					ESC C
Half-duplex block mode on	ESC D H ESC B	Same		Same	ENH
Set Serial 1 port receive handshaking protocol	ESC c 2 <i>hndshk</i>	Same	ENH		
Set Serial 1 port transmit handshaking protocol	ESC c 4 <i>hndshk</i>	Same	ENH		
Set maximum data transmission speed for host port	ESC c 6 <i>max</i>				
Set Serial 1 port operating parameters	ESC c 0 <i>baud stop parity word</i>				
Set Serial 2 port operating parameters	ESC c 1 <i>baud stop parity word</i>				
Enable DTR Serial port 1 Handshaking			CTRL N	CTRL N	CTRL N
Enable X-on/X-off Serial port 1			CTRL O	CTRL O	CTRL O
Program answerback message	ESC c; <i>answer</i> CTRL Y	Same	ENH		
Conceal answerback message	ESC c =	Same	ENH		
Send answerback message	ESC c <	Same	ENH		
Turn answerback mode off	ESC e SP	Same	ENH		
Turn answerback mode on	ESC e !	Same	ENH		
Controlling the Terminal and Keyboard					
Sound bell	CTRL G	Same	Same	Same	Same
Select <i>bell volume</i>	ESC c \ <i>volume</i>	Same	ENH		
Unlock keyboard	CTRL N or ESC"	Same	CTRL B	ESC "	ESC "
Lock keyboard	CTRL O or ESC#	Same	CTRL D	Same	ESC #
CAPS LOCK off	ESC e '	ENH	ENH	ENH	ESC SP M
CAPS LOCK on	ESC e &	ENH	ENH	ENH	ESC SP L
NUM LOCK off	ESC e @	ENH	ENH	ENH	ESC SP K
NUM LOCK on	ESC e A	ENH	ENH	ENH	ESC SP J
SCROLL LOCK off	ESC e B	ENH	ENH	ENH	ESC SP O
SCROLL LOCK on	ESC e C	ENH	ENH	ENH	ESC SP N
Keyclick off	ESC e \$	Same	ENH	ESC <	ESC <
Keyclick on	ESC e %	Same	ENH	ESC >	ESC >
Margin bell off	ESC e L	Same	ENH	ENH	ESC n
Margin bell on	ESC e M	Same	ENH	ENH	ESC o
Set margin bell at curs position	ESC ' J	Same	ENH		
Select standard ASCII key code mode	ESC e H	Same	ENH		
Select PC scan code mode	ESC e I	Same	ENH		
Key repeat off	ESC e ,	Same	ENH	ENH	
Key repeat on	ESC e -	Same	ENH	ENH	
Read keyboard status					ESC [
Redefining the keys					
Clear function key definition	ESC z <i>fkey</i> DEL	Same			
Clear key direction and definition	ESC Z <i>dir key/fkey</i> DEL	Same	ENH		

Table 10- Commands Supported in ASCII Personalities (Cont'd)

FUNCTION	Native Mode	Wyse WY-50+	ADDS VP A2	TVI 910+/925	PC Term
-Program function key definition	ESC z <i>fkey sequence</i> DEL	Same	ENH	ENH	
Program key direction and definition	ESC Z <i>dir key/fkey sequence</i> DEL	Same		Wyse	ESC <i>p1 p2 sequence</i> CTRL Y
Read key direction and definition	ESC Z ~ <i>key</i> or ESC Z ~ <i>fkey</i>	Same			
Screen and Cursor Display					
Screen display off	ESC ` 8	Same	ENH	ESC o	ESC O
Screen display on	ESC ` 9	Same	ENH	ESC n	ESC N
Screen saver off	ESC e P	Same	ENH	ENH	
Screen saver on	ESC e Q	Same	ENH	ENH	
Set reverse screen	ESC ^ 1	Same	ENH	ESC b	
Restore normal screen	ESC ^ 0	Same	ENH	ESC d*4	
Set scrolling speed and type	ESC ` <i>scroll</i>	Same	ENH		
Smooth scrolling on				ESC 8*5	
Smooth scrolling off				ESC 9*5	
Set cursor display features	ESC ` <i>cursor</i>	Same	ENH	ESC . <i>cursor1</i>	ESC. <i>cursor1</i>
Cursor display off	ESC ` 0	Same	CTRL W		
Cursor display on	ESC ` 1	Same	CTRL X		
25th line display off				ESC e	
Displaying the Message Fields					
Extended status line on	ESC ` a	Same	ENH		
Standard status line on	ESC ` b	Same	ENH		
Status line off	ESC ` c	Same	ENH		
Program/display CPU message on status line	ESC F <i>message</i> CR	Same	ENH		
Program CPU message on unshifted label line*6	ESC z (<i>text</i> CR	Same	ENH	ESC f*5 <i>text</i> CR	ESC f <i>text</i> CR
Program CPU message on shifted label line	ESC z) <i>text</i> CR	Same	ENH		
Turn off shifted label line	ESC z DEL	Same	ENH	ENH	
Clear unshifted label line	ESC z (CR	Same	ENH		
Clear shifted label line	ESC z) CR	Same	ENH	ENH	
Program/display function key label	ESC z <i>field label</i> CR	Same	ENH	ENH	
Clear function key label	ESC z <i>field</i> CR	Same	ENH	ENH	
Defining the data Area					
Select 80-column display	ESC ` :	Same	ENH		
Select 132-column display	ESC ` ;	Same	ENH		
Economy 80-column mode off	ESC e F	Same	ENH		
Economy 80-column mode on	ESC e G	Same	ENH		
Width-change-clear mode off	ESC e .	Same	ENH		
Width-change-clear mode on	ESC e /	Same	ENH		
Display 24 data lines*7	ESC e (Same	ENH		
Display 25 data lines*7	ESC e)	Same	ENH		ESC ^

Table 10- Commands Supported in ASCII Personalities (Cont'd)

FUNCTION	Native Mode	Wyse WY-50+	ADDS VP A2	TVI 910+/925	PC Term
Display Memory/Split Screen					
Divide memory into pages	ESC w <i>length</i>	Same	ENH		
Display previous page	ESC w B or ESC J*8	Same	ENH	ESC J	
Display next page	ESC w C or ESC K*8	Same	ENH	ESC K	
Display page n	ESC w <i>page</i>	Same	ENH		
Split screen horizontally (simple split)	ESC x A <i>line</i>	Same			
Split screen horizontally (simple split) and clear pages	ESC x 1 <i>line</i>	Same			
Split screen horizontally (adjustable split) and clear pages	ESC x 3 <i>line</i>	Same			
Split screen horizontally (adjustable split)	ESC x C <i>line</i>	Same			
Activate upper window	ESC]	Same			
Activate lower window	ESC }	Same			
Activates other window (or page *8)	ESC J or ESC K	Same	ESC J*5		
Lower horizontal split	ESC x P	Same			
Raise horizontal split	ESC x R	Same			
Roll window up in page	ESC w E	Same			
Roll window down in page	ESC w F	Same			
Redefine screen as one window	ESC x @	Same			
Redefine screen as one window and clear pages	ESC x 0	Same			
Display Attributes					
Assign display attribute to a message field	ESC A <i>mf attr</i>	Same	ESC *4		
Assign character display attribute	ESC G <i>attr</i>	Same	ENH	Same	Same
Character attribute mode off	ESC e 0				
Character attribute mode on	ESC e 1				
Page attribute mode on	ESC e 2	Same			
Line attribute mode on	ESC e 3	Same			
Assign write-protected character display attribute	ESC ` <i>wpca</i>	Same	ESC 0 <i>wpca1</i>		
Clear unprotected page to display attribute	ESC !	ENH	Wyse		
Assign line attribute	ESC G <i>lattr</i>	Same	ENH		
Redefine color map values*9	ESC d y <i>fcolor</i> <i>bcolor map</i>				
Set tag protect attribute			CTRL N		
Reset tag protect attribute			CTRL O		
Select a predefined color palette*9	ESC d z <i>palette</i>				
Map blank attribute*9	ESC d {				
Map reverse attribute*9	ESC d				
Protecting Data					
Write-protect mode off	ESC (Same	CTRL O	Same	Same
Write-protect mode on	ESC)	Same	CTRL N	Same	Same
Clear cursor column to write-protected spaces	ESC V	Same	ENH	Same	
Protect mode off	ESC ,	Same	ENH	Same	Same
Protect mode on	ESC &	Same	ENH	Wyse	Same

Table 10- Commands Supported in ASCII Personalities (Cont'd)

FUNCTION	Native Mode	Wyse WY-50+	ADDS VP A2	TVI 910+/925	PC Term
Graphics Characters					
Graphics mode on	ESC H	CTRL B	Same	ESC \$	ESC \$
Graphics mode off	ESC H	CTRL C	Same	ESC %	ESC %
Display graphics character	ESC H <i>ldraw</i>	Same			
Controlling the Cursor					
Cursor left (backspace)	CTRL H	Same	Same	Same or CTRL U	Same
Cursor right	CTRL L	Same	CTRL F	Same	Same
Cursor up; no scroll	CTRL K	Same	CTRL Z	Same	Same
Cursor up; scroll (reverse linefeed)	ESC j	Same	ENH	Same*10	Same
Cursor down; no scroll				CTRL V	CTRL V
Cursor down; scroll (Linefeed)	CTRL J	Same	Same	Same	Same
Cursor to start of line	CTRL M	Same	Same	Same	Same
Cursor to start of next line	CTRL _	Same	ENH	Same	Same
Home cursor	ESC { or CTRL ^	Same	ENH or CTRL A	Wyse Same	CTRL ^
Cursor to specific column			CTRL P <i>col</i>	ESC] +11	
Cursor to specific line			CTRL K <i>line</i>	ESC [
End-of-line wrap off	ESC d .	Same	ENH		ESC 0
End-of line wrap on	ESC d /	Same	ENH		ESC ~
Received CR mode off	ESC e 4	Same	ENH	ENH	ESC 9
Received CR mode on	ESC e 5	Same	ENH	ENH	ESC 8
Autopage mode off	ESC d *	Same	ENH	ESC w	
Autopage mode on	ESC d +	Same	ENH	ESC v	
Autoscrolling mode off	ESC N	Same	ENH		
Autoscrolling mode on	ESC O	Same	ENH		
Address cursor in current 80-column page	ESC = <i>line col</i>	Same	ENH or ESC Y	Same	Same
Address cursor in specific 80-column page	ESC w @ <i>page line col</i>	Same	ENH	ESC - <i>page line col</i>	
Address cursor in specific 80-column window/page+8	ESC - <i>wnd/page line col</i>	Same	ENH		Same
Address cursor in specific 80/132-column current page	ESC a <i>lll R ccc C</i>	Same	ENH		Same
Read cursor line and column address in 80-column current page	ESC ?	Same	ENH	Same	Same
Read 80-column page number and cursor address	ESC w □	Same	ENH		
Read 80-column window/page number and cursor address	ESC /	Same	ENH	Same	Same
Read cursor address in 80/132-column page	ESC b	Same	ENH		
Editing					
Clear all tab stops	ESC 0	Same	ENH	ESC 3	ESC 3
Set tab stop	ESC 1	Same	ENH	Same	Same
Clear tab stop	ESC 2	Same	ENH	Same	Same
Tabulate cursor	ESC i or CTRL I	Same	ENH	CTRL I	CTRL I
Backtab	ESC I	Same	ENH	Same	Same
Field tab				ESC I	ESC i
Insert mode on, replace mode off	ESC q	Same	ENH	ENH	ESC Z
Insert mode off, replace mode on	ESC r	Same	ENH	ENH	Same
Insert space character	ESC Q	Same	ENH	Same	Same

Table 10- Commands Supported in ASCII Personalities (Cont'd)

FUNCTION	Native Mode	Wyse WY-50+	ADDS VP A2	TVI 910+/925	PC Term
Editing (Cont'd)					
Insert line of spaces	ESC E	Same	ENH	Same	Same
Delete cursor character	ESC W	Same	ENH	Same	Same
Delete cursor line	ESC R	Same	ESC I	Same	Same
Clearing Data					
Clear page to nulls	ESC *	Same	ENH	Same	Same
Clear page to spaces	ESC +	Same	ENH		
Clear page to write-protected spaces	ESC ,	Same	ENH		Same
Clear unprotected page to spaces	ESC ; or CTRL Z	Same	ESC ; ENH	ESC ; or ESC +	Same
Clear unprotected page to nulls	ESC :	Same	ENH	Same	Same
Clear unprotected page to a specific character	ESC . <i>char</i>	Same	ENH		
Clear unprotected page to protected spaces				ESC ,	
Clear unprotected page to display attribute		ESC ! <i>attr</i>	ENH	ENH	
Clear unprotected page to spaces from cursor	ESC Y	Same	ESC k	Same	Same
Clear unprotected page to nulls from cursor	ESC y	Same	ENH	Same	Same
Clear unprotected line to spaces from cursor	ESC T	Same	ESC K	Same	Same
Clear unprotected line to nulls from cursor	ESC t	Same	ENH	Same	Same
Fill page with H's					ESC F
Sending data					
Begin print / send at top of page	ESC d'	Same	ENH		
Begin print / send at top of screen	ESC d&	Same	ENH		
Send cursor character	ESC M	Same			
Send line through cursor	ESC 6	Same	Same	ESC 6	
Send unprotected line through cursor	ESC 4	Same	Same	ESC 4	
Send page through cursor	ESC 7	Same	ENH	Same	ESC 7
Send unprotected page through cursor	ESC 5	Same	Same	ESC 5	
Mark block beginning	ESC 8	Same	ENH		
Mark block end	ESC 9	Same	ENH		
Send entire block	ESC s	Same	ENH	Same	Same
Send unprotected	ESC S	Same	ENH	Same	Same
Report terminal status					ESC [
Report attribute under cursor					ESC D

Table 10- Commands Supported in ASCII Personalities (Cont'd)

FUNCTION	Native Mode	Wyse WY-50+	ADDS VP A2	TVI 910+/925	PC Term
Print Functions					
Print formatted page	ESC P	Same	ENH	Same	Same
Print formatted unprotected page	ESC @	Same	ENH		
Print unformatted page	ESC p or ESC L	Same	ESC p	ESC L*11	
Select Parallel printer	ESC d (Same	Same		
Select Serial printer	ESC d)	Same	Same		
Auxiliary print mode off	CTRL T	Same	Same	ESC A	ESC A
Auxiliary print mode on	CTRL R	Same	Same	ESC @	
Transparent print mode off	CTRL T	Same	ESC 4	ESC a	ESC a
Transparent print mode on	ESC d #	Same	ESC 3	ESC `	ESC `
Bi-directional mode off	ESC d \$			CTRL T	CTRL T
Bi-directional mode on	ESC d %			CTRL	CTRL R
Auxiliary receive mode off	ESC d SPACE				
Auxiliary receive mode on	ESC d !				
Set print terminator				ESC p	ESC p
Define delimiters				ESC x	ESC x
Character Sets					
Select primary character set	ESC c D	Same			
Select secondary character set	ESC c E	Same			
Define primary character set	ESC c B bank	Same			
Define secondary character set	ESC c C bank	Same			
Load font bank with predefined	ESC c @ bank set	Same			
Clear font bank	ESC c ? bank	Same			
Define and load character	ESC c A bank pp bb...bb CTRL Y	Same			

*1. PCG ALPHA in Mono. Text Model machine.

*3. Valid only in Color Model machine.

*4. With enhance mode off.

*5. With enhance mode on.

*6. Automatically display in native mode. May be hidden by assigning blank attribute (ESC A I I).

*7. Screen cleared.

*8. If screen is not split.

*9. In WY-325 only

*10. In TeleVideo 925 only

*11. In TeleVideo 910+ only

5.2 Variable Values for Table 10 Commands

answer Up to 20 characters to define answerback message

<i>attr</i>	Display Attributes	<i>attr</i>	Display Attributes
SPACE	Space character	p	Dim
0	Normal	q	Dim and invisible
1	Blank	r	Dim and blink
2	Blink	s	Dim, blink, invisible
3	Blink and Blank	t	Dim and reverse
4	Reverse	u	Dim, reverse, invisible
5	Reverse and invisible	v	Dim, reverse, blink
6	Reverse and blink	w	Dim, reverse, blink invisible
7	Reverse, blink, invisible	x	Dim and underline
8	Underline	y	Dim, underline, invisible
9	Underline and invisible	z	Dim, underline, blink
:	Underline and blink	{	Dim, underline, blink invisible
;	Underline, blink, invisible		Dim, underline, reverse
<	Underline and reverse	}	Dim, underline, reverse invisible
=	Underline, reverse, invisible	~	Dim, underline, reverse blink
>	Underline, reverse, blink	DEL	Dim, underline, reverse blink, invisible
?	Underline, reverse, blink invisible		

<i>bank</i>	Font Bank ^{*a}	<i>bank</i>	Font Bank ^{*a}
0	Font bank 0	2	Font bank 2
1	Font bank 1	3	Font bank 3

*a Holds predefined character set

<i>baud</i>	Baud Rate	<i>baud</i>	Baud Rate	<i>baud</i>	Baud Rate	<i>baud</i>	Baud Rate
0	115200	4	19200	8	2400	<	200
1	76800	5	9600	9	1200	=	134.5
2	57600	6	7200	:	600	>	110
3	38400	7	4800	:	300	?	50

bb...bb 32-byte character string defining bit pattern of character

<i>bcolor</i>	Background Color	<i>bcolor</i>	Background Color
1	Black	5	Red
2	Blue	6	Magenta
3	Green	7	Yellow
4	Cyan	8	White

ccc One-to three-decimal value of column relative to home

char Character that replaces unprotected characters

col See line/col

<i>color</i>	color	<i>color</i>	color	<i>color</i>	color
1	Black	6	Magenta	D	Dim cyan
2	Blue	7	Yellow	E	Dim red
3	Green	8	White	F	Dim magenta
4	Cyan	B	Dim blue	G	Dim yellow
5	Red	C	Dim green	H	Dim white

<i>cursor</i>	Cursor Display	<i>cursor</i>	Cursor Display
0	Cursor display off	3	Blinking line cursor
1	Cursor display on	4	Steady line cursor
2	Steady block cursor	5	Blinking block cursor

<i>dir</i>	Direction
0	Normal
1	Remote
2	Local

Variable Values for Table 10 Commands (Cont'd)

<i>fcolor</i>	Foreground Color	<i>fcolor</i>	Foreground Color
1	Black	5	Red
2	Blue	6	Magenta
3	Green	7	Yellow
4	Cyan	8	White

Function Key	<i>field</i> unshifted	<i>field</i> shifted
F1	0	P
F2	1	Q
F3	2	R
F4	3	S
F5	4	T
F6	5	U

Function Key	<i>field</i> unshifted	<i>field</i> shifted
F7	6	V
F8	7	W
F9	8	X
F10	9	Y
F11	:	Z
F12	;	[

Function Key	<i>fkey</i> unshifted	<i>fkey</i> shifted
F1	@	`
F2	A	a
F3	B	b
F4	C	c
F5	D	d
F6	E	e

Function Key	<i>fkey</i> unshifted	<i>fkey</i> shifted
F7	F	f
F8	G	g
F9	H	h
F10	I	i
F11	J	j
F12	K	k

<i>hndshk</i>	Handshaking Protocol	
	Receive	Transmit
0	None (default)	None (default)
1	XON/XOFF	XON/XOFF
2	DTR	
3	Both	

Keyboard Style

<i>key</i>	Enhanced PC	<i>key</i>	Enhanced PC	<i>key</i>	Enhanced PC
SPACE	ESC	&	SHIFT TAB →	\$	RETURN
%	SHIFT ESC	"	← BACKSPACE)	SHIFT RETURN
!	TAB →	'	SHIFT ← BACKSPACE	*	HOME
/	SHIFT HOME	3	SHIFT →	6	SHIFT DELETE
+	↑	s	ENTER kpd	R	PRINT SCREEN
0	SHIFT ↑	4	SHIFT ENTER kpd	X	SHIFT PRINT SCREEN
,	↓	q	INSERT	\	END
1	SHIFT ↓	p	SHIFT INSERT]	SHIFT END
-	←	r	PAGE DOWN	:	PAGE UP
2	SHIFT ←	w	SHIFT PAGE DOWN	;	SHIFT PAGE UP
.	→	5	DELETE		

label 9 characters (80 columns); 7 characters (132 columns)

<i>lattr</i>	Line Attribute
@	Single-high, single-wide characters
A	Single-high, double-wide characters.
B	Top half of double-high, single-wide characters
C	Bottom half of double-high, single-wide characters
D	Top half of double-high, double-wide characters
E	Bottom half of double-high, double-wide characters

<i>ldraw</i>	Graphics Character	<i>ldraw</i>	Graphics Character	<i>ldraw</i>	Graphics Character	<i>ldraw</i>	Graphics Character
0	┌	4	┐	8	┴	=	┘
1	└	5	┑	9	┬	>	┙
2	┒	6	┓	:	┼	?	┚
3	┕	7	└	;	├		┛

Variable Values for Table 10 Commands (Cont'd)

length	Multiple	Length of Page
G	1xlines	Equal to the number of data lines
H	2xlines	Double the number of data lines
I ^{*b}	4xlines	Four times the number of data lines

*b Available only in WY-50+ personality.

Line/Column	line/col _c	Line/Column	line/col _c	Line/Column	line/col _c	Line/Column	line/col _c
1	Space	25	8	49	P	73	h
2	!	26	9	50	Q	74	i
3	"	27	:	51	R	75	j
4	#	28	;	52	S	76	k
5	\$	29	<	53	T	77	l
6	%	30	=	54	U	78	m
7	&	31	>	55	V	79	n
8	'	32	?	56	W	80	o
9	(33	@	57	X	81	p
10)	34	A	58	Y	82	q
11	*	35	B	59	Z	83	r
12	+	36	C	60	[84	s
13	,	37	D	61	\	85	t
14	-	38	E	62]	86	u
15	.	39	F	63	^	87	v
16	/	40	G	64	_	88	w
17	0	41	H	65	`	89	x
18	1	42	I	66	a	90	y
19	2	43	J	67	b	91	z
20	3	44	K	68	c	92	{
21	4	45	L	69	d	93	
22	5	46	M	70	e	94	}
23	6	47	N	71	f	95	~
24	7	48	O	72	g	96	DEL/RUB

*c Native codes also recognized in WY-50+, TVI 910+/925, and PC Term personalities, and in ADDS VP A2 personality absolute cursor addressing.

/// One- to three-decimal value of line relative to home

map	Definition	map	Definition
1	Normal	5	Underline
2	Reverse (or blank ^{*d})	6	Underline and reverse (or blank ^{*d})
3	Intensity	7	Underline and intensity
4	Intensity and reverse (or blank ^{*d})	8	Underline, intensity, and reverse (or blank ^{*d})

*d. Colors mapped to reverse or blank depending on the setting of the Color Map setup parameter or the equivalent escape sequences.

Max	Maximum Speed
1	60 characters per second
2	No limit (default)
3	150 characters per second

message 46 characters (80 columns); 98 characters (132 columns)

mf	Screen Area ^{*e}	mf	Screen Area ^{*e}
0	Data area	2	Terminal message field
1	Function key label line	3	Computer message field

*e In native mode, only the reverse attribute can be assigned to the data area.

Variable Values for Table 10 Commands (Cont'd)

<i>p1</i>	Function Key	<i>p1</i>	Function Key
1	F1	6	F6
2	F2	7	F7
3	F3	8	F8
4	F4	9	F8
5	F5	0	F10

<i>P2</i>	Function Key
1	Remote
2	Local
3	Normal

<i>Page</i>	Page	
0	page 0	In the 80 columns mode: There have 4 pages of display memory.
1	page 1	In the 132 columns mode: There have 3 pages of display memory.
2	page 2	In the Econ-80 columns mode: There have 7 pages of display memory.
3	page 3	
4	page 4	
5	page 5	
6	page 6	

<i>Palette</i>	Color Palette	<i>Palette</i>	Color Palette	<i>Palette</i>	Color Palette
0	Palette 0	4	Palette 4	8	Palette 8
1	Palette 1	5	Palette 5	9	Palette 9
2	Palette 2	6	Palette 6	.	Palette 10
3	Palette 3	7	Palette 7		

<i>Parity</i>	Parity Bits	<i>Parity</i>	Parity Bits
0	None	2	Mark
1	Odd	3	Even

pp 2-byte hex value of character position**f*.

**f* In the illustrations, DEC = decimal value; HEX = hexadecimal value. Read across, then down.

<i>Scroll</i>	Scrolling Type	<i>Speed (lps)</i>
@	Jump scroll	
<	Smooth scroll	1
=	Smooth scroll	2
>	Smooth scroll	4
?	Smooth scroll	8

sequence Up to 64 bytes to be loaded in function key

<i>Set</i>	Predefined Character Set
@	Native Mode
A	PC Multinational
B	Standard ASCII
D	PC Standard
G	Standard ANSI

<i>Stop</i>	stopbits
0	1
1	2

text 78 characters (80 columns); 130 characters (132 columns)

<i>Volume</i>	BELL Volume	<i>Volume</i>	BELL Volume
#	Loud	!	Low
"	Medium	SP	Off

Variable Values for Table 10 Commands (Cont'd)

wnd/page	Window or Page
0	Page 0 or upper window
1	Page 1 or lower window

Word	Data Word
0	7 bits
1	8 bits

wpca	Write-Protected Display Attribute	wpca	Write-Protected Display Attribute
6	Reverse* g	C	Invisible on
7	Dim* g	E	Underline on
A	Normal* g	F	Reverse on
B	Blink on	G	Dim on

***g** Clears other write-protected attributes

wpca1	Display Attribute	wpca1	Write-Protected Display Attribute
@	Normal	H	Normal
A	Dim	I	Dim
B	Blink	J	Blink
C	Dim/Blink	K	Dim/Blink
D	Invisible	L	Invisible
P	Reverse (Rev)	X	Reverse (Rev)
Q	Rev/Dim	Y	Rev/Dim
R	Rev/Blink	Z	Rev/Blink
S	Rev/Dim/Blink	[Rev/Dim/Blink
T	Rev/Invisible	\	Rev/Invisible
.	Underline (UL)	h	Underline (UL)
a	UL/Dim	i	UL/Dim
b	UL/Blink	j	UL/Blink
c	UL/Dim/Blink	k	UL/Dim/Blink
p	UL/Rev	x	UL/Rev
q	UL/Rev/Dim	y	UL/Rev/Dim
r	UL/Rev/Blink	z	UL/Rev/Blink
s	UL/Rev/Dim/Blink	{	UL/Rev/Dim/Blink

6. ANSI COMMAND GUIDE

6.1 VT100, VT220 and Console ANSI Command Guide

Supported VT100,VT220 and Console ANSI Commands

FUNCTION	Command	
	VT100, VT220	Console ANSI
Controlling Functional modes*1		
Lock keyboard	CSI 2 h	Same
Unlock keyboard	CSI 2 l	Same
Monitor mode on *2	CSI 3 h	Same
Monitor mode off	CSI 3 l	Same
Insert mode on	CSI 4 h	Same
Insert mode off	CSI 4 l	Same
Local echo off	CSI 12 h	Same
Local echo on	CSI 12 l	Same
New line mode on	CSI 20 h	Same
New line mode off	CSI 20 l	Same
Cursor keys send application-dependent codes	CSI ?1 h	Same
Cursor keys send cursor movement codes	CSI ?1 l	Same
VT100 mode on	CSI ?2 h or CSI 61 "p	Same
VT52 mode on	CSI ?2 l	Same
National character set mode on	CSI ?42 h	Same
National character set mode off	CSI ?42 l	Same

Supported VT100, VT220 and Console ANSI Commands, Cont'd

FUNCTION	Command	
	VT100, VT220	Console ANSI
132-column display	CSI ?3 h	Same
80-column display	CSI ?3 l	Same
Smooth scrolling on	CSI ?4 h	Same
Jump scrolling on	CSI ?4 l	Same
Reverse screen video on	CSI ?5 h	Same
Normal screen video on	CSI ?5 l	Same
Line 1 is top of scrolling region	CSI ?6 h	Same
Line 1 is top of display area	CSI ?6 l	Same
Autowrap on	CSI ?7 h	Same
Autowrap off	CSI ?7 l	Same
Autorepeat on	CSI ?8 h	Same
Autorepeat off	CSI ?8 l	Same
Block mode on	CSI ?10 h	Same
Block mode off	CSI ?10 l	Same
Send form feed after print screen operation	CSI ?18 h	Same
No form feed sent after print screen operation	CSI ?18 l	Same
Print full screen	CSI ?19 h	Same
Print scrolling region	CSI ?19 l	Same
Display cursor	CSI ?25 h	Same
Cursor off	CSI ?25 l	Same
Blank screen	CSI 30 h	Same
Display screen	CSI 30 l	Same
Display status line	CSI 31 h	Same
Blank status line	CSI 31 l	Same
Screen saver	CSI 32 h	Same
Screen saver off	CSI 32 l	Same
Cursor steady (nonblinking)	CSI 33 h	Same
Cursor blinking	CSI 33 l	Same
Underline cursor on	CSI 34 h	Same
Block cursor on	CSI 34 l	Same
Don't clear screen after width change	CSI 35 h	Same
Clear screen after width change	CSI 35 l	Same
Send erasable and nonerasable characters	CSI 37 h	Same
Send only erasable characters	CSI 37 l	Same
Send full screen	CSI 38 h	Same
Send scrolling region	CSI 38 l	Same
Turn 25th line on	CSI 40 h	Same
Turn 25th line off	CSI 40 l	Same
Select standard ANSI key codes	CSI 54 h	Same
Select PC scan codes	CSI 54 l	Same
VT220 8-bit mode on	CSI 62;2"p	Same
VT220 7-bit mode on	CSI 62;1"p	Same
8-bit transmission mode on (VT220)	ESC space G	
7-bit transmission mode on (VT220)	ESC space F	
Select next page		CSI U
Select preceding page		CSI V
Select page 0		CSI 0 z
Select page 1		CSI 1 z

Character Set Selection

ESC Ps final

Same

Ps	Label assigned	Ps	Label assigned
(G0	*	G2 (VT220 only)
)	G1	+	G3 (VT220 only)

Supported VT100, VT220 and Console ANSI Commands (Cont'd)

<i>final</i>	Final character	<i>final</i>	Final character
A	Designating UK ANSI character set	<	Designating DEC supplemental(VT220 only)
B	Designating ASCII character set	DSCS	Designating Down-line loadable character set
0	Designating DEC special graphics		

* DSCS can consist of zero, one or two intermediate character and a final character. Intermediate characters are in the range of 2/0 to 2/15. Final characters are in the range of 3/0 to 7/14

FUNCTION	Command	
	VT100, VT220	Console ANSI
Load G0 character set into GL Load G1 character set into GL Load G1 character set into GR Load G2 character set into GL Load G2 character set into GR Load G3 character set into GL Load G3 character set into GR Shift G2 character set into GL for one character only Shift G3 character set into GL for one character only	CTRL O CTRL N ESC ~ ESC n ESC } ESC o ESC ESC N ESC O	Same Same Same Same Same Same Same Same Same Same
Controlling Character, Field, and Line Attributes		
Define character attributes₃	CSI Ps m (see table below)	Same
Select Graphic Rendition (Console ANSI mode only)		CSI ps m (see table below)
Set bold background bit <i>Pn</i> = 0: set bit 7 of attribute byte as B/G intensity 1: set bit 7 of attribute byte as B/G blink Set normal foreground color Set normal background color Set reverse foreground color Set reverse background color Set graphic foreground color Set graphic background color Set border color	ESC[= <i>Pn</i> E ESC[= <i>Psn</i> F (see table, next page) ESC[= <i>Psn</i> G ESC[= <i>Psn</i> H ESC[= <i>Psn</i> I ESC[= <i>Psn</i> J ESC[= <i>Psn</i> K ESC[= <i>Psn</i> A	same same same same same same same same

Values for "Ps" (above)

<i>Ps</i>	Character Attribute	<i>Ps</i>	Character Attribute
0	Normal (all attributes off)	33	Brown character (Bold on = Yellow)
1	Bold (blank off)	34	Blue character
4	Underline	35	Magenta character
5	Blink	36	Cyan character
7	Reverse	37	White character
8	Blank (bold off)	40	Black background
22	Normal intensity	41	Red background
24	Underline off	42	Green background
25	Blink off	43	Brown background (Bold on = Yellow)
27	Reverse off	44	Blue background
28	Blank off	45	Magenta background
30	Black character	46	Cyan background
31	Red character	47	White background
32	Green character		

Values for "ps" (above)

<i>ps</i>	Function
10	Select Primary Font
11	Select First Alternate Font. Allows ASCII characters less than 32 to be displayed as ROM character.
12	Select Second Alternate Font. Toggles high bit of extended ASCII code before displaying as ROM character.

Supported VT100, VT220 and Console ANSI Commands (Cont'd)

Values for "Psn" in table on page 56

Psn	Color	Psn	Color	Psn	Color	Psn	Color
0	Black	4	Red	8	Gray	12	Lt. Red
1	Blue	5	Magenta	9	Lt. Blue	13	Lt. Magenta
2	Green	6	Brown	10	Lt. Green	14	Yellow
3	Cyan	7	White	11	Lt. Cyan	15	Lt. White

FUNCTION	Command	
	VT100, VT220	Console ANSI
Access alternate graphic set		CSI Png
Define erasable character	CSI 0 "q or CSI 2 "q	Same
Define non-erasable character	CSI 1 "q	Same
Define top half of double-high, double-wide line	ESC # 3	Same
Define bottom half of double-high, double-wide line	ESC # 4	Same
Define single-high, single-wide line	ESC # 5	Same
Define single-high, double-wide line	ESC # 6	Same
Define top half of double-high, single-wide line	ESC # :	Same
Define bottom half of double-high, single-wide line	ESC # ;	Same
Controlling the Cursor		
Display cursor	CSI ?25 h	Same
Cursor off	CSI ?25 l	Same
Cursor steady (nonblinking)	CSI 33 h	Same
Cursor blinking	CSI 33 l	Same
Underline cursor on	CSI 34 h	Same
Block cursor on	CSI 34 l	Same
Cursor keys send application-dependent codes	CSI ?1 h	Same
Cursor keys send cursor movement codes	CSI ?1 l	Same
Move cursor to n column	CSI n G or CSI n `	Same
Move cursor up n lines	CSI n A	Same
Move cursor down n lines	CSI n B or CSI n e	Same
Move cursor right n columns	CSI n C or CSI n a	Same
Move cursor left n columns	CSI n D	Same
Move cursor down cursor n line to column 1	CSI n E	Same
Move cursor up n lines to column 1	CSI n F	Same
Move cursor to line n	CSI n d	Same
Move cursor to line n1, column n2	CSI n1; n2 H or CSI n1; n2 f	Same
Move cursor down one line in current column, scroll up if at bottom line	IND or ESC D	Same
Move cursor down one line in current column, execute CR if linefeed mode is on	CTRL J or CTRL K or CTRL L	Same
Move cursor up one line in current column, scroll down if at top line	RI or ESC M	Same
Move cursor down one line to column 1	NEL or ESC E	Same
Save display attributes, cursor position, character sets, wrap flag and origin mode status	ESC 7 or CSI s	Same
Restore last saved display attributes, cursor position, character set, wrap flag, and origin mode status	ESC 8 or CSI u	Same
Backspace cursor	CTRL H	Same
Move cursor to next tab stop	CTRL I	Same
Move cursor to column 1 of current line	CTRL M	Same
Editing Functions		
Erase from cursor to end of display	CSI 0 J	Same
Erase from start of display to cursor	CSI 1 J	Same
Erase entire display	CSI 2 J	Same
Erase from cursor to end of line	CSI 0 K	Same
Erase from start of line to cursor	CSI 1 K	Same
Erase entire line	CSI 2 K	Same
Erase erasable characters from cursor to end of display	CSI ?0 J	Same

Supported VT100, VT220 and Console ANSI Commands (Cont'd)

FUNCTION	Command	
	VT100, VT220	Console ANSI
Editing Functions (Cont'd)		
Erase erasable characters from start of display to cursor	CSI ?1 J	Same
Erase erasable characters in entire display	CSI ?2 J	Same
Erase erasable characters from cursor to end of line	CSI ?0 K	Same
Erase erasable characters from start of line to cursor	CSI ?1 K	Same
Erase erasable characters from entire line	CSI ?2 K	Same
Erase n characters beginning at cursor	CSI n X	Same
Insert n blank characters beginning at cursor	CSI n @	Same
Insert n blank lines beginning at cursor line	CSI n L	Same
Delete n line beginning at cursor line	CSI n M	Same
Delete n characters beginning at cursor	CSI n P	Same
Controlling Margins		
Set top/bottom margins of scrolling	CSI t; b r	Same
<i>t</i> : Top line number <i>b</i> : Bottom line number (optional; if omitted, treated as bottom screen line)		
Controlling Tabs		
Clear tab stop at cursor	CSI 0 g or CSI 2 W	CSI 2W
Clear all tab stops	CSI 3 g or CSI 5 W	CSI 5W
Set tab stop at cursor	CSI 0 W or ESC H	Same
Set tab stop every 8th column	CSI ?5 W	Same
Move forward n tab stops	CSI n I	Same
Move backward n tab stops	CSI n Z	Same
Move cursor to next tab stop	CTRL I	Same
Controlling Scrolling		
Smooth scrolling on	CSI ?4 h	Same
Jump scrolling on	CSI ?4 l	Same
Set 0 lps smooth scrolling speed	CSI 0 z	
Set 1 lps smooth scrolling speed	CSI 1 z	
Set 2 lps smooth scrolling speed	CSI 2 z	
Set 4 lps smooth scrolling speed	CSI 3 z	
Set 8 lps smooth scrolling speed	CSI 4 z	
Program function keys <i>(see tables below an on next page for values)</i>	DCS c;kl kclhc ST	ESC Q Fn "string"

Program function key values in VT100 mode:

c	Clear	kl	Key Lock
0	Clear all key definitions	0	Lock key definitions
1	Clear keys only as they are redefined	1	Don't lock key definitions
kc	Shifted function key	kc	Shifted function key
12	F1	18	F7
13	F2	19	F8
14	F3	20	F9
15	F4	21	F10
16	F5	23	F11
17	F6	24	F12

Supported VT100, VT220 and Console ANSI Commands, Cont'd

kc	Unshifted function key	kc	Unshifted function key
6	F1	38	F7
7	F2	39	F8
8	F3	40	F9
9	F4	41	F10
10	F5	43	F11
37	F6	44	F12

hc Hexadecimal representation of character string assigned to the function key.

Note: Multiple function key definitions can be programmed by entering the <kc>/<hc> parameters for each, separated by semicolons (;).

Program function key values (from previous page) in Console ANSI mode:

Redefine keys with string

Function: Define Specific Programmable Function key or Numeric keypad with String.

Format: ESC Q Fn " string "

Values of Fn for Programmable Function keys

Fn Value	F Key	Fn Value	F Key	Fn Value	F Key	Fn Value	F Key
0	F1	<	S_F1	H	C_F1	T	C_S_F1
1	F2	=	S_F2	I	C_F2	U	C_S_F2
2	F3	>	S_F3	J	C_F3	V	C_S_F3
3	F4	?	S_F4	K	C_F4	W	C_S_F4
4	F5	@	S_F5	L	C_F5	X	C_S_F5
5	F6	A	S_F6	M	C_F6	Y	C_S_F6
6	F7	B	S_F7	N	C_F7	Z	C_S_F7
7	F8	C	S_F8	O	C_F8	[C_S_F8
8	F9	D	S_F9	P	C_F9	\	C_S_F9
9	F10	E	S_F10	Q	C_F10]	C_S_F10
:	F11	F	S_F11	R	C_F11	^	C_S_F11
;	F12	G	S_F12	S	C_F12	_	C_S_F12

Values of Fn for Numeric Keypad keys

Fn Value	Numeric Keypad Key	Fn Value	Numeric Keypad Key	Fn Value	Numeric Keypad Key	Fn Value	Numeric Keypad Key
-	7	c	-	f	6	i	2
a	8	d	4	g	+	j	3
b	9	e	5	h	1	k	0

Notes:

- The string should not include the delimiter, or unexpected conditions maybe occur.
- The defined contents of F1 ~F12 will be transmitted out by keying F1~F12.
 The defined contents of S_F1~S_F12 will be transmitted out by multi-keying the Shift and Function key.
 The defined contents of C_F1~C_F12 will be transmitted out by multi-keying the Ctrl and Function key.
 The defined contents of C_S_F1~C_S_F12 will be transmitted out by multi-keying the Ctrl, Shift and Function key.

Example: Define Function Key F1 to the character ABC123: ESC Q 0"ABC123"

Supported VT100, VT220 and Console ANSI Commands (Cont'd)

FUNCTION	Command	
	VT100, VT220	Console ANSI
Auxiliary Keypad Modes		
Auxiliary keypad numeric mode on	ESC >	Same
Auxiliary keypad application mode on	ESC =	Same
Transmission/Printer Control		
Transmit through cursor position	CSI 16 h	Same
Transmit to end of line or end of display	CSI 16 l	Same
Send form feed after print screen operation	CSI ?18 h	Same
No form feed sent after print screen operation	CSI ?18 l	Same
Print full screen	CSI ?19 h	Same
Print scrolling region	CSI ?19 l	Same
Print screen	CSI 0 i or CSI i	Same
Send screen	CSI 2 i	Same
Transparent print mode off	CSI 4 i	Same
Transparent print mode on	CSI 5 i	Same
PR port receive mode off	CSI 6 i	Same
PR port receive mode on	CSI 7 i	Same
Select parallel printer	CSI 8 i	Same
Select serial printer	CSI 9 i	Same
Print line	CSI ?1 i	Same
Send line	CSI ?3 i	Same
Copy print mode off	CSI ?4 i	Same
Copy print mode on	CSI ?5 i	Same
Transmit form feed after send screen operation	CSI 1	Same
No form feed after send screen operation	CSI 0	Same
Send characters at cursor	ESC 5	Same
Send answerback message	CTRL E	Same
Suspend transmission	CTRL S	Same
Resume transmission	CTRL Q	Same
More Terminal Control Commands		
Display screen adjustment pattern	ESC # 8	Same
Sound bell, if enabled	BEL (CTRL G)	Same
Abort escape sequence; no character displayed ^{†3}	CAN (CTRL X)	Same
Abort escape sequence; display reverse question mark [^]	SUB (CTRL Z)	Same
Initiate escape sequence	ESC (CTRL [])	Same
Next Page	CSI U	Same
Preceding Page	CSI V	Same
Terminal Resets		
Soft terminal reset	CSI ! p	Same
Hard terminal reset	ESC c	Same
Terminal Status Reports		
Request primary attributes report	CSI 0 c or ESC Z	Same
Request secondary attributes report	CSI > 0 c	Same
Respond with current revision	CSI > 1; 20; 0c	Same
Request terminal status report	CSI 5 n	Same
Respond terminal functioning and ready	CSI 0 n	Same
Request cursor position report	CSI 6 n	Same
Respond cursor at line l, column c	CSI l; c R	Same
Request printer status report	CSI ?15 n	Same
Respond printer ready	CSI ?10 n	Same
Respond printer not ready	CSI ?11 n	Same
Respond printer not connected	CSI ?13 n	Same
Request function key status report	CSI ?25 n	Same
Respond key definitions not locked	CSI ?20 n	Same
Respond key definitions locked	CSI ?21 n	Same

Supported VT100, VT220 and Console ANSI Commands, Cont'd

FUNCTION	Command	
	VT100, VT220	Console ANSI
Request keyboard status report Respond with keyboard language (see table below for values of "Ps")	CSI ? 26 n CSI ? 27; Ps n	Same Same

Values of Ps (above)

Ps	Keyboard Language	Ps	Keyboard Language
1	U.S.	6	Spanish
2	U.K.	7	Swedish
3	Danish	8	Norwegian
4	German	9	Italian
5	French		

*1. More than one mode, but less than 17, may be set with one sequence. Enter multiple numeric parameters separated by semicolons (;). However you cannot combine sequences containing "?" with those that don't contain "?", nor can you combine sequences ending with "h" with those ending with "l".

*2. To toggle monitor mode from the keyboard, press CTRL SHIFT 1 (use the 1 on the numeric keypad).

*3. In VT52 or VT100 modes, displays checkerboard character.

6.2 VT52 Command Guide

Table 11- VT52 Mode Escape Sequences

Command	VT52
Move cursor up one line	ESC A
Move cursor down one line	ESC B
Move cursor right one column	ESC C
Move cursor left one column	ESC D
Move cursor to home position	ESC H
Move cursor up one line with scroll	ESC I
Move cursor to line <i>line</i> , column <i>col</i>	ESC Y <i>line col</i>
Select graphics character set	ESC F
Select U.S. ASCII character set	ESC G
Erase from cursor to end of display	ESC J
Erase from cursor to end of line	ESC K
Print cursor line	ESC V
Print display	ESC]
Transparent print mode on	ESC W
Transparent print mode off	ESC X
Copy print mode on	ESC ^
Copy print mode off	ESC _
Keypad application mode on	ESC =
Keypad application mode off	ESC >
Enter VT100 mode	ESC <
Identify terminal	ESC Z

7. USING PRINTER SERVER IN ETHERNET TERMINAL

Introduction

There are two ways to send the print jobs to Ethernet Terminal for printing: 1) through LPD protocol, and 2) through TFTP protocol.

- The LPD method is more suitable for printing environments with a large number of users because the LPD protocol has a queue process so print jobs will be kept in the print queues in the CPU.
- TFTP does not implement the print queue concept; if the printer port is not ready for accepting new print jobs, TFTP will be terminated. Consequently, the user must send the print job again. As a result, the TFTP protocol is suitable for printing small jobs, in an environment with a small number of users, or for testing purposes.

LPD is a built-in printing protocol in the BSD type of UNIX and is also available in most other UNIX systems. With LPD, users do not need to install additional software to the CPU to print the jobs. Most implementations of the LPD protocol send out the data file before the control file. However, since Ethernet Terminal must print the data file immediately upon receiving it, the print option specified in the control file cannot take effect.

To install the printer server function of Ethernet Terminal, the first step is Basic Setup. Whichever printing protocol will be used, it is necessary to follow "Basic Setup" first (below). If LPD will be used to print jobs, go through the "Setup for LPD" procedures (below). If TFTP will be used, go through the "Setup for TFTP" procedures (page 37).

7.1 Basic Setup

Because the TCP/IP world uses IP addressing to communicate with each other, the purpose of Basic Setup is to assign an IP address to the Ethernet Terminal.

For the purpose of this explanation, assume the following:

- (1) Login to the UNIX CPU as root
- (2) The Ethernet terminal is on the same network segment that the CPU resides.

Step 1. Add the Print Server to /etc/hosts

Create a new entry in the /etc/hosts file on all UNIX CPUs that are slated to work with Ethernet Terminal. To create a new entry, add the following line:

```
IP_Address PS_NAME # comment
```

where: IP_Address is an IP address.
PS_NAME is a CPU name of a print server.
The statement after # is the comment for the new entry.

e.g. 90.3.2.2 ETPS1 # Ethernet Terminal

This example assigns the name ETPS1 to the Ethernet Terminal with IP address 90.3.2.2.

NOTE: The IP address is defined in the setup screen of Ethernet Terminal, as a Local IP address. Use the same one.

Step 2. Check to see if the above steps are completed

To verify if the IP address of print Server function is installed successfully, issue the following "ping" command:

```
ping PS_NAME [Enter]
```

e.g. ping ETPS1 [Enter]

7.2 Setup for LPD

Follow those steps from step 1 to step 2 described in Basic Setup. The following steps are dependent on the operating system. Please refer to the UNIX administration guide. The following illustrated steps are under BSD system.

Step 3. Create a spooling directory

Use mkdir command to create a directory for spooling.

e.g. mkdir/usr/spool/ETPS1

Step 4. Make the directory available to LPD main process

Basically, the method has the following three procedures:

- 1) Assign the spooling daemon as the owner of this directory.
- 2) Allow the spooling daemon to be able to read from or write to the directory.
- 3) Enable the group of LPD main processes to be able to read from or write to the directory.

e.g. If it works on a BSD UNIX host and makes the directory /usr/spool/ETPS1 (created in step 3) available, then follow these three procedures:

```
chown daemon /usr/spool/ETPS1
chmod 775 /usr/spool/ETPS1
chgrp daemon /usr/spool/ETPS1
```

Step 5. Add a remote printer

To add a remote printer, insert a block similar to the following in the /etc/printcap file.

```
Printer_name|Remote Printer on Ethernet Terminal:\
:lp=\
:rm=PS_NAME:\
:rp=Logic_Printer_name:\
:sd=<full path of spooler directory name>:\
```

e.g. If Ethernet Terminal works on a BSD UNIX host, then insert the following block into /etc/printcap file.

```
ETPS1|Remote Printer on Ethernet Terminal:\
:lp=\
:rm=ETPS1:\
:rp=L1:\
:sd=/usr/spool/ETPS1:\
```

Step 6. Start CPU's print mechanism for BSD version UNIX system

Typing: lpc start printer_name [Enter]

e.g. lpc start ETPS1 [Enter]

Now the Ethernet Terminal is configured to accept LPD printing..

7.3 LPD printing

LPD protocol is built-in to most of the UNIX system. However, detailed implementation of LPD differs among UNIX systems. Please refer to the UNIX administration guide for reference. The following illustrated printing command is under BSD system or System V version.

For BSD system: lpr -P <printer_name><filename>
 For System V version: lp -d <printer_name><filename>

This command is to print selected file to the selected printer.

e.g. lpr -PETPS1 /etc/hosts (BSD version) or lp -dETPS1 /etc/hosts (System V version)
 This example is to print the /etc/hosts file to the Ethernet Terminal printer.

7.4 Setup for TFTP

When working on the BSD UNIX system, run the setup procedure under Setup for LPD on page 34. Otherwise run the Setup for LPD omitting step 6.

7.5 TFTP Printing

Before using TFTP printing, the Ethernet Terminal needs to be installed completely by Setup for TFTP on page 34. TFTP Printing lets the user send print jobs to the printers directory. There are no spooling mechanisms involved. Consequently, if that printer is not ready, the TFTP process will be terminated immediately without sending print jobs to printers. The user must make sure the printer is ready to print before issuing the TFTP command to have a successful result.

Log into the Ethernet Terminal with this command:

```
tftp <PS_NAME>
```

and then type:

```
put <file Name> Ln
```

where Ln is a logic printer for L1 to L8

e.g. tftp ETPS1
tftp > put /etc/hosts L1

This example prints the /etc/hosts file to the logic printer 1 of Ethernet Terminal Printer ETPS1.

8. ON-SCREEN DISPLAY (OSD)

8.1 Standard Controls

The RACKMUX LCD has 5 standard control buttons and a power LED. The 5 standard control buttons operate as follows:

- The **Power** button turns the RACKMUX LCD and backlight ON and OFF as desired.
- The **Power LED** located immediately below the Power button is a dual color LED. It will illuminate with a green color when the RACKMUX is powered ON and working properly. It will illuminate with a red color if the RACKMUX is powered ON but there is no input signal detected. The LED will illuminate red only momentarily just before turning OFF.
- The **Menu** button is used to bring up the OSD menu where the various settings of the LCD display can be adjusted. Once the OSD screen is displayed, the Menu button is used to make selections within the menus. See "OSD Control Menu " (below) for more on LCD display settings.
- The **Up and Down Arrow** buttons are used to navigate through the menus. Move the cursor up or down as desired to highlight an item for selection. Once an item is highlighted, pressing the Menu button will select it.
- The **Select** button is used to make selections within the OSD menus when the OSD menu is ON. When the OSD menu is OFF, the Select button will act as an **Auto Adjust** button to keep the user from having to use the menus to adjust the quality of the image on the monitor.

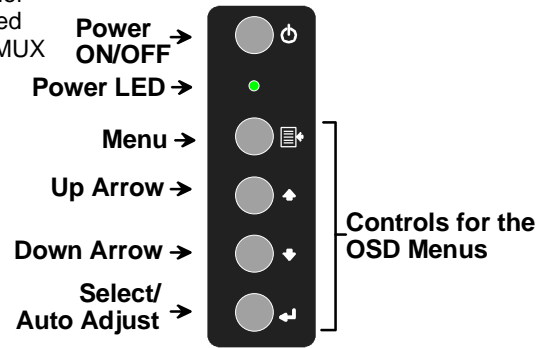

Figure 7- OSD Controls

8.2 OSD Control Menu

The OSD (On Screen Display) Menu enables the user to select the desired characteristics of the LCD display. To activate the OSD Menu, press the Menu button (above). To turn the Menu back OFF, either select "EXIT" from the main menu or just wait 10-60 seconds and it will automatically be cleared from the screen.

8.2.1 OSD Main Menu



Selection	Purpose	Range
Brightness/Contrast	Increase/decrease panel brightness/contrast level	1-100
Color	R,G,B color temperature control	1-100
Position	<ul style="list-style-type: none"> • Auto Adjust • Video Image horizontal and vertical position control • Clock setting • Phase control 	1-100
Setup	<ul style="list-style-type: none"> • Control OSD Image position on screen • Set time OSD will stay on screen before auto shutoff • Select the language of the OSD menu 	-- 10 to 60 seconds Several languages (see page 40)
Exit	Exit from the OSD control menu	

8.2.2 Brightness/Contrast Menu

Selecting the Brightness/Contrast menu will bring up a screen in which the user can adjust the brightness and contrast levels of the LCD display. With either the BRIGHTNESS or CONTRAST sections highlighted, (use the Up or Down arrow to move between them), press the Select button to choose the option to adjust. Then use the Up or Down Arrow to adjust the setting. Select EXIT when finished to return to the Main Menu.



8.2.3 Color Menu

Selecting the Color menu will bring up a screen in which the user can adjust the Red, Green, and Blue color levels (values from 1-100) of the LCD display. With the RED, GREEN, or BLUE sections highlighted, (use the Up or Down arrow to move between them), press the Select button to choose the option to adjust. Then use the Up or Down Arrow to adjust the setting. Select EXIT when finished to return to the Main Menu.

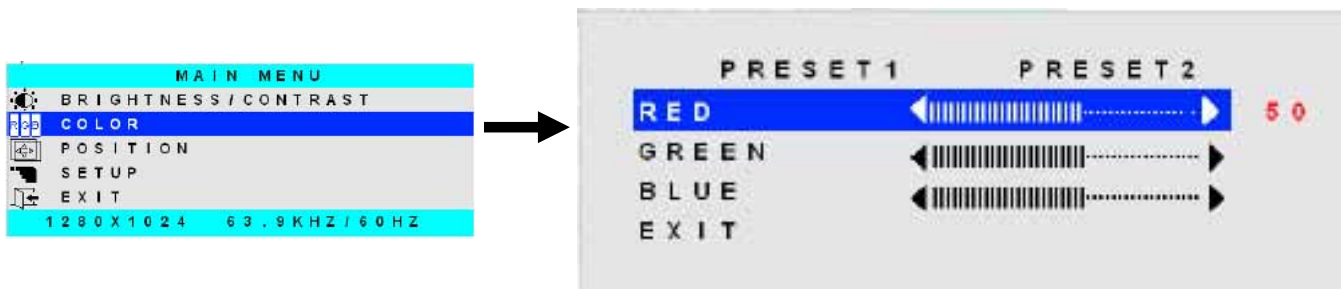

8.2.4 Position Menu

Selecting the Position menu will bring up a screen in which the user can select AUTO ADJUST to automatically adjust the horizontal and vertical position of the displayed image on the monitor, as well as adjust the clock and phase settings if they are not correct. The user can also individually adjust these settings if so desired. With any of the sections highlighted, (use the Up or Down arrow to move between them), press the Select button to choose the option to adjust. Then use the Up or Down Arrow to adjust the setting as needed. Select EXIT when finished to return to the Main Menu.

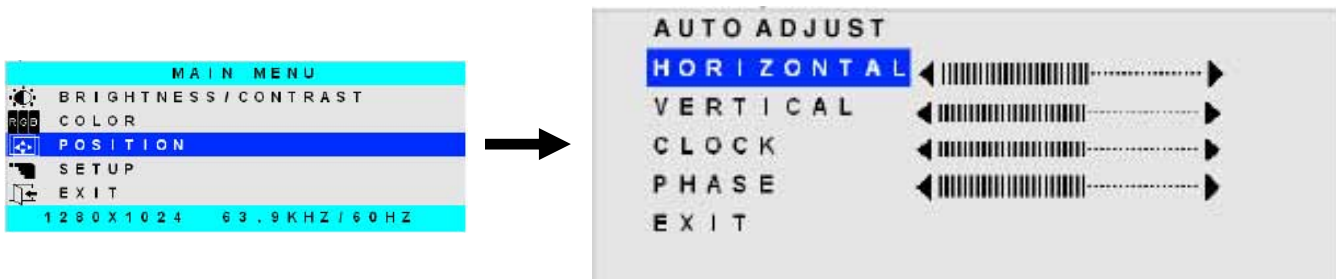

8.2.5 Setup Menu

Selecting the Setup menu will bring up a screen in which the user can adjust

- OSD POSITION-the position of the OSD menus on the LCD display
- OSD TIME-the length of time the user can be idle before the OSD menu automatically exits (adjustable from 10 to 60 seconds)
- LANGUAGE-the language that the OSD menus will be presented in

With the item highlighted, (use the Up or Down arrow to move between them), press the Select button to choose the option to adjust. Then use the Up or Down Arrow to adjust the setting as needed. Select EXIT when finished to return to the Main Menu.

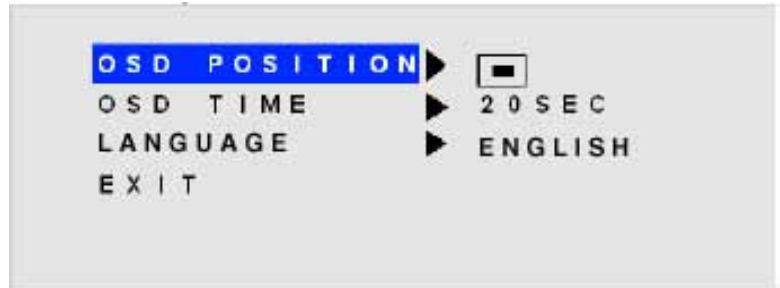

OSD Image can be moved to different points on the display

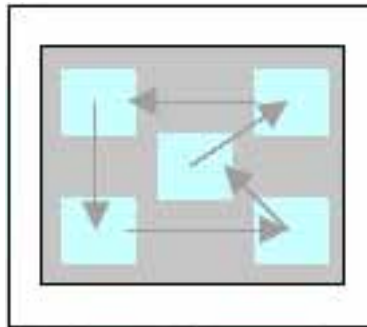

9. KEYBOARD FUNCTIONS

The keyboard on the RACKMUX has a standard condensed Windows format. To reduce the keyboard size, some keys have been assigned multiple functions, accessible via the "Fn" key. This section will describe which keys have multiple functions and how to enable them.

9.1 Function Key Operation

The Function ("Fn") key provides special functions on the RACKMUX keyboard, including:

- enabling otherwise standard keyboard keys to be used as the keys of a numeric keypad
- enabling multi-function keys to change operation

To turn ON (lock) the Function key, press the "Fn" key twice quickly (double-click). The "Fn" LED will illuminate.

To turn OFF (unlock) the Function key, press the "Fn" key twice quickly again. The "Fn" LED will turn OFF.

Note: The "Fn" key will also operate similar to the shift key (with only momentary effect). Press and hold the "Fn" key prior to pressing the special function key. The "Fn" key will remain active as long as it is depressed.

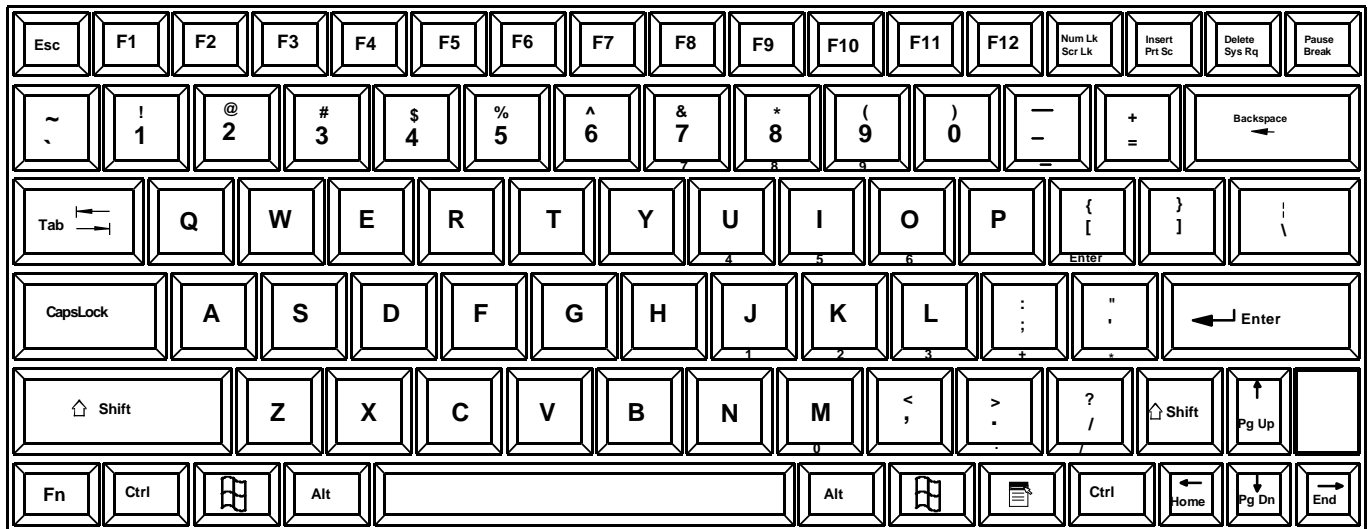

↑
"Fn" Key to enable additional key functions

Figure 8- US (English) Keyboard Layout

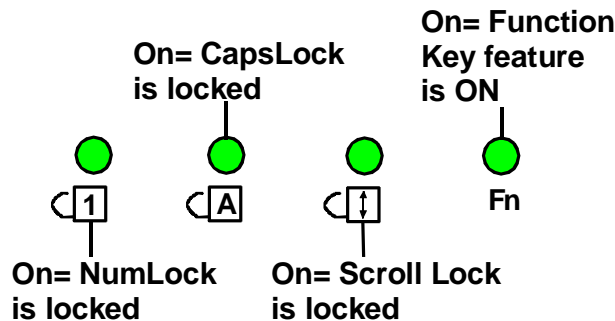



Figure 9- Keyboard LED Indications

9.2 Number Pad

The functionality of a Number Pad on a standard Windows keyboard has been incorporated into this keyboard. To substitute the keys of the Number Pad

To substitute the keys of the Number Pad:

1. Press the "NumLock" key. The NumLock LED () will illuminate.
2. Press the "Fn" key twice quickly (double-click). The "Fn" LED will illuminate.

To turn OFF Number Pad functions:

1. Press the "Fn" key twice quickly (double-click). The "Fn" LED will turn OFF.
2. Press the "NumLock" key. The NumLock LED () will turn OFF.

Note: For only momentary function of the "Fn" key, press and hold the "Fn" key (similar to the "Shift" key). Upon release the Fn feature will be OFF.

With the "Fn" and "NumLock" LEDs illuminated, pressing some standard keys will result in displaying characters as indicated in the chart below. (See also Fig. 10, page 44)

Table 12- Number Pad Keys

Standard Key	Displayed when NumLock is ON	Function when NumLock is OFF
j	" 1 "	End
k	" 2 "	Down Arrow
l	" 3 "	Page Down
u	" 4 "	Left Arrow
i	" 5 "	---
o	" 6 "	Right Arrow
7	" 7 "	Home
8	" 8 "	Up Arrow
9	" 9 "	Page Up
m	" 0 "	Insert
.	" . "	Delete
(period)	(period)	
/	" / "	
(forward slash)	(forward slash)	
;	" + "	
(semicolon)	(plus sign)	
'	" * "	
(apostrophe)	(asterisk)	
-	" - "	
(hyphen)	(minus sign)	
[ENTER	
(left bracket)		

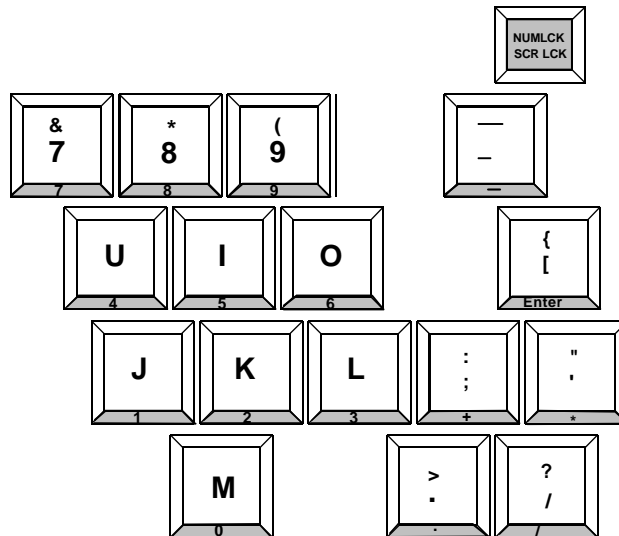

Figure 10- Keys of the Number Pad

9.3 Other Uses of the Function Key

The Function ("Fn") key (page 43) will enable other standard keyboard features in addition to the Number Pad keys (page 44) .

Key Function when Fn key is not locked ("Fn" LED is OFF)	Key Function when Fn key is Locked ("Fn" LED is ON)
Numlck (Number lock)	Scr Lck (Scroll Lock)
Insert	Prt Sc (Print Screen)
Delete	Sys Rq (System Requirements)
Pause	Break
Up Arrow	Page Up
Down Arrow	Page Down
Left Arrow	Home
Right Arrow	End

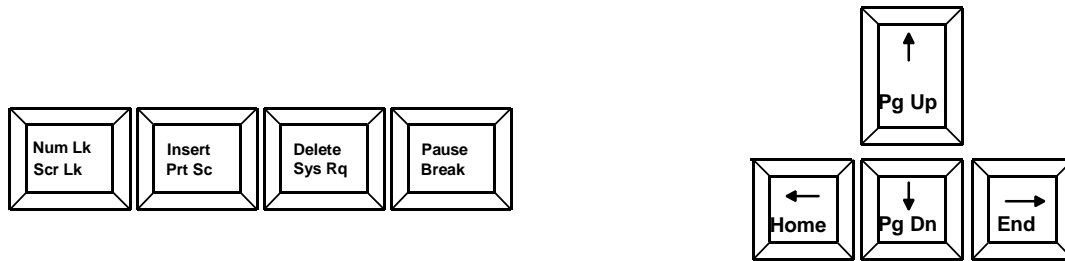

Figure 11- Additional multi-function keys

Note: The "Fn" key will also operate similar to the shift key (with only momentary effect).

9.4 Numeric Keypad Option

Models with the Numeric Keypad option (-N) (i.e. RACKMUX-T15-N) have a standard Windows keyboard with 17-key numeric keypad.

Note: The "Fn" key is not an active key on this keyboard.

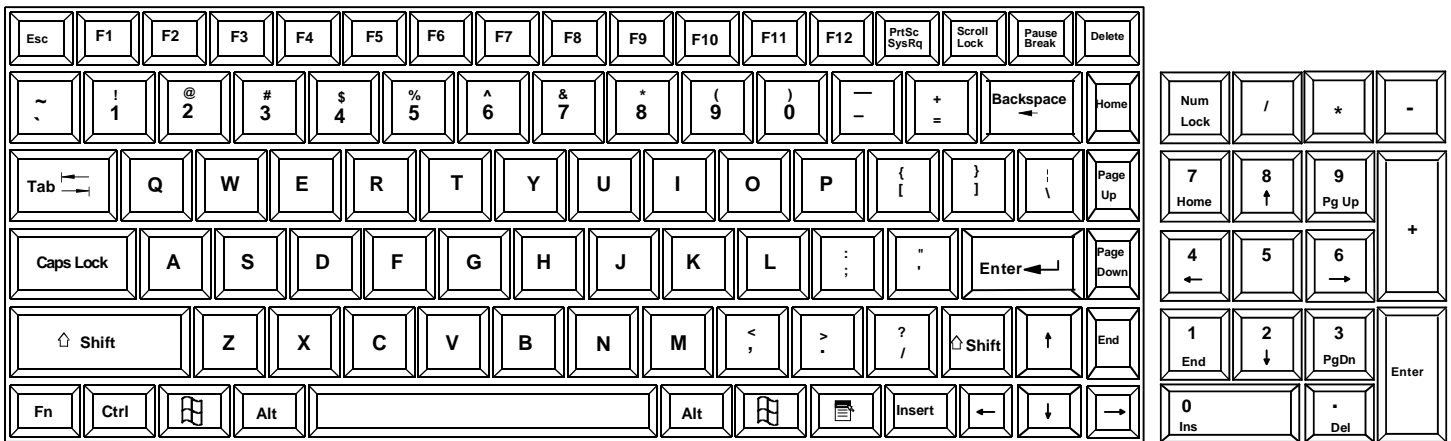

Figure 12- U.S. (English) Keyboard with numeric keypad

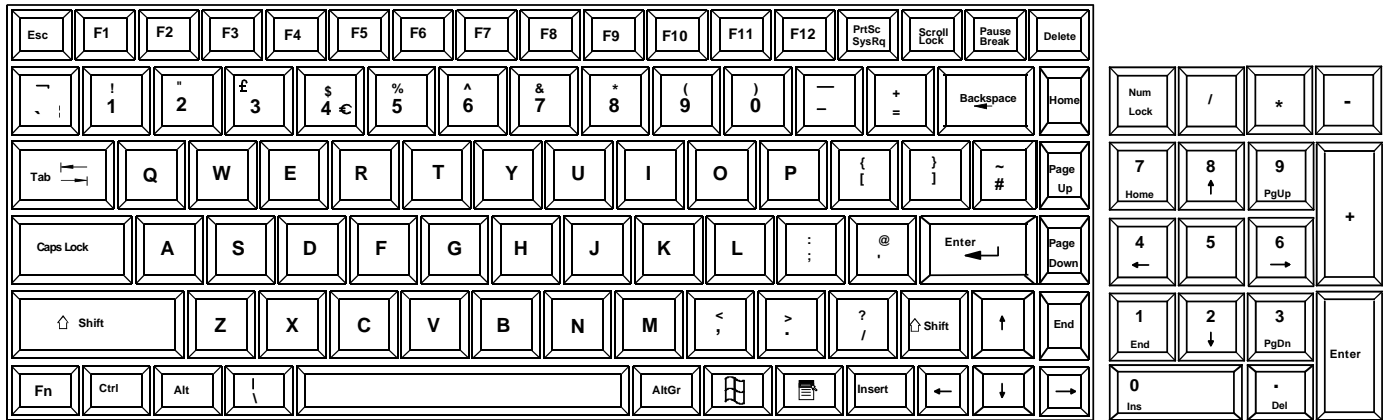

Figure 13- U.K. (English) keyboard with numeric keypad

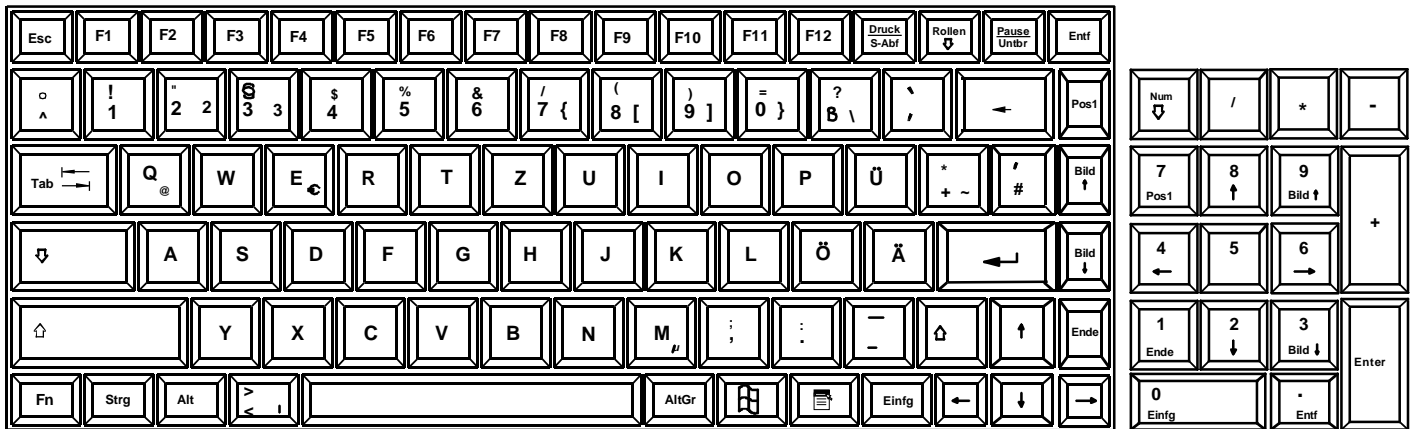
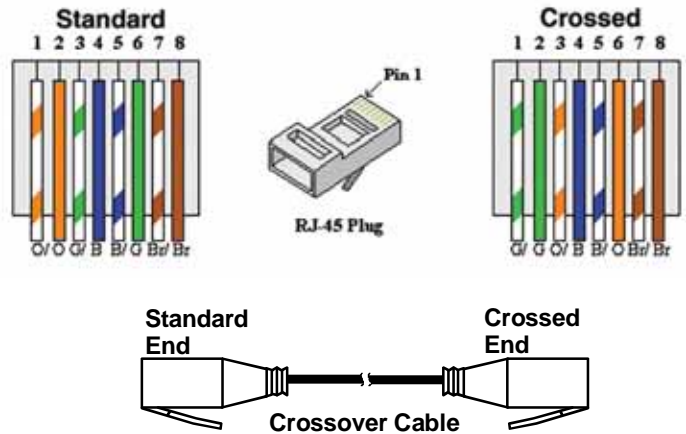

Figure 14- German keyboard with numeric keypad

10. CPU-TO-RACKMUX ETHERNET CROSSOVER CABLE

In order to make a direct connection between a CPU and the ETHERNET connector of the RACKMUX, a crossover cable must be used. The cable is made with CAT5 cable terminated with RJ45 connectors and wired according to the chart below.

Pin assignment at Standard End	Wire Color	Pin assignment at Crossed End
1	White/Orange	3
2	Orange	6
3	White/Green	1
4	Blue	4
5	White/Blue	5
6	Green	2
7	White/Brown	7
8	Brown	8



11. DC POWER OPTION

If the RACKMUX has been ordered with the DC Power option (“48V” at the end of the model number), a 3-terminal block has been provided for connection to a 36-72VDC 2A power source. The terminal block can be easily removed from under the protective bracket to make connections. Proper connections are indicated.

Note: Be sure to properly secure the terminal block to the RACKMUX after wire insertion.

An earth ground terminal has been provided for optional use.

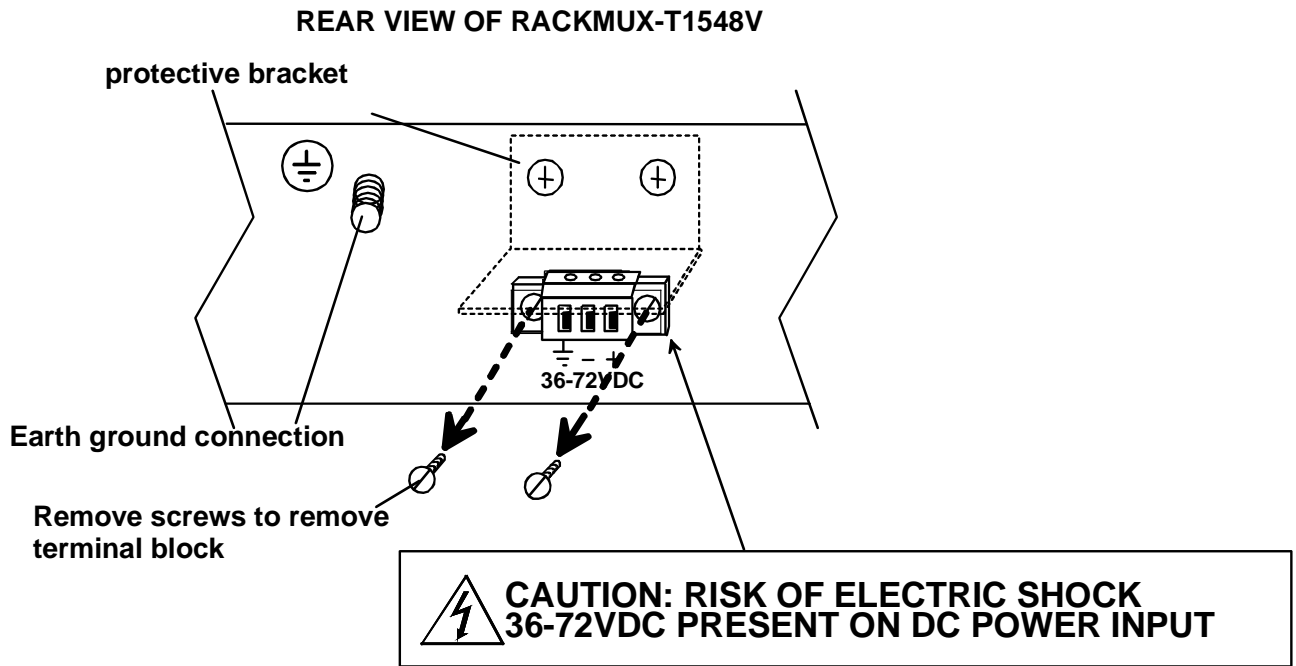

Figure 15- RACKMUX with DC Power option

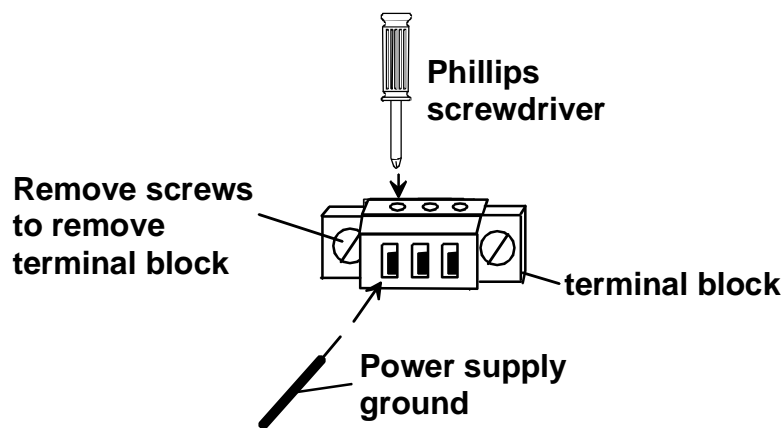
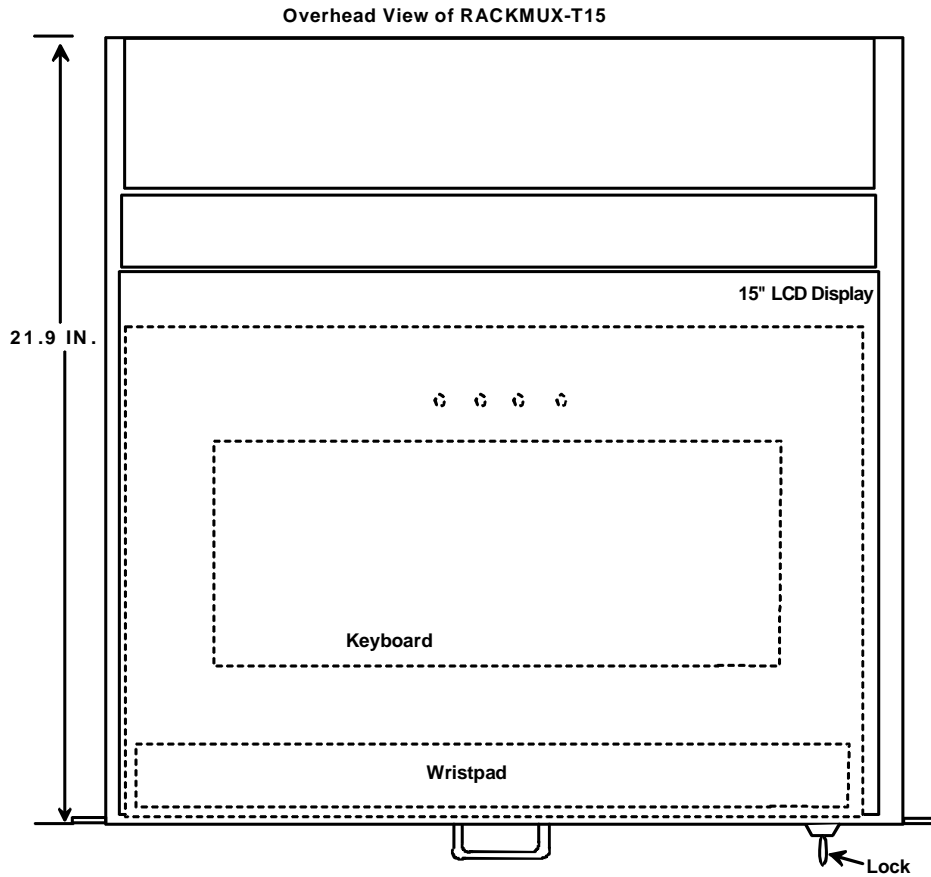
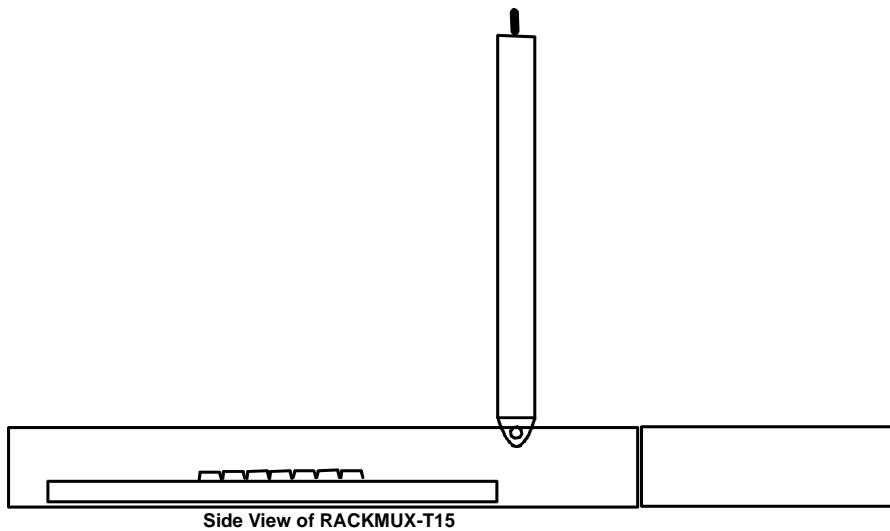
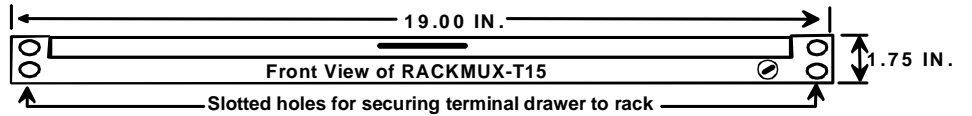

Figure 16- Apply wires to terminal block

DIMENSIONAL DRAWINGS



Rear View of RACKMUX-T15



FREQUENTLY ASKED QUESTIONS

Questions and Answers

Q. What servers can the monitor be used with?

A. All Sun and headless servers to date include at least one serial RS232 port that is used as a console port when no directly connected keyboard is present. The Ethernet console connection should only be used with servers that include an Ethernet RSC (Remote System Control) port. Both RS232 serial and Ethernet telnet connections cannot be active at the same time.

Q. How do I connect the terminal to a single server using a RS232 serial connection?

A. An RS232 cable is required for connection to a server with either a male DB25 or DB9 serial port. When connecting to a Sun server with a RJ45 console port, use the RJ45 cable and RJ45 to DB25 adapter which are included with the server. If the RJ45 to DB25M adapter and RJ45 cable are not available, contact NTI to order DB25M-RJ45F-T (adapter) and a Cat5 Patch cable (RJ45) of the desired length.

Q. How do I connect the terminal to multiple servers using a RS232 serial connection?

A. A Console Server must be used to connect the terminal to multiple servers. Ensure that the appropriate cables are ordered for connection to the Sun servers in addition to a terminal cable terminating in a female DB9 (or male DB25 when used in conjunction with the included adapter) connection. To connect to a server, the operator will first connect to the Console Server, and then use Console Server functionality to connect to the server.

Q. What is the format of the server serial connection on the terminal?

A. The pin out adheres to a standard female 9 pin [PC] connector.

Q. How do I connect the terminal to a single server using an Ethernet telnet connection?

A. When connecting to a Sun server with an Ethernet RSC console port, a crossover or cascade Ethernet cable may be used. Alternatively, an Ethernet switch and standard RJ45 cat 5 Ethernet cables may be used. When using an Ethernet switch, it is advisable that this network remains private for security reasons.

Q. How do I connect the terminal to multiple servers using an Ethernet telnet connection?

A. An Ethernet switch must be used to connect the terminal to multiple servers. Standard RJ45 Cat 5 Ethernet cables should be used to connect the switch to the terminal and servers. In use, the operator can switch the terminal connection between [up to] 12 servers by using the hot key sequence ALT-F1 through to ALT-F12. The state of each server session is preserved by the terminal. It is advisable that the network used to connect the server consoles remains private for security reasons.

Q. How many servers are supported by the Ethernet telnet connection?

A. The terminal allows up to 12 Ethernet connected servers to be configured.

Q. Does the terminal require an IP address when using an Ethernet connection?

A. Yes. This is defined during terminal set up.

Q. Is any server configuration required?

A. When the terminal loses power or is powered OFF, a 'break' may be generated on the RS232 host communications port (as is common with most general purpose terminals). To prevent this halting a Sun server, ensure that the "alternate break" sequence is configured. See SunSolve Info Doc 21258 for details. If connecting the terminal using the RS232 connection to a Console Server, an alternate break sequence may not be required since some Console Servers are "Break Safe" (as is the case with all Sun UK marketed Console Servers). Refer to the Console Server documentation for details. When using an Ethernet console connection, the alternate break sequence need not be defined. However, the RSC Ethernet port must be configured using the "rscconfig" command.

Q. Does the keyboard support any Sun specific keys?

A. No. Character terminals are non Sun specific, and do not require any special keys. The Break key can be used to enter the Open Boot PROM "OK" prompt.

Q. What character resolutions does the terminal support?

A. The standard resolution is 80x24 plus a status line displayed using 800x600 pixels.

Q. What rack can I mount the unit in?

A. The rack mounted monitor has been qualified in the Sun StorEdge 72" and Sun Fire racks. Although it is not possible to guarantee, the rack mounted monitor should be compatible with other EIA 19" racks.

Q. What is the warranty?

A. The warranty period on this product (parts and labor) is two (2) years from the date of purchase.

TECHNICAL SPECIFICATIONS

Physical	
Size (In.) WxDxH	19x21.9x1.725
Weight	23.3 lbs.
Temperature	0°~40°C operating, -20°~60°C storage
Humidity	20% to 90% non-condensing
Power Supply (Standard)	110/220VAC, 50-60Hz
Power Supply (RACKMUX-T15-48V model only)	36-72VDC
Power Consumption	60W (max), <25W (standby)
Cables Included	IEC Power cord (country specific), 1-1/2 foot 15HD VGA, 6 foot DB9 female to DB25 male null modem cable
Rack mount kit	Included for Sun & most EIA 22-36" racks
LCD Panel Specifications	
Screen size	15.1" visible diagonal
Display format	800x600
Controls	contrast, brightness, auto-adjust, color temperature
Brightness	250cd/m ² (Nits)
Contrast	500:1 (typical)
Viewing Angle	140° H / 125° V
Keyboard Specifications	
Type	83 key (US) / 84 key (Europe)
Terminal Emulation	
Emulations	VT52, VT100, VT220, Console ANSI, PC TERM, TVI910+/925, WY-50+, WY-60, WY-100, WY-120, WY-325, PCG Alpha
Character matrix	7x12 dot matrix in 10x16 cell with 3 dot descenders
Screen size	80x25
Page length	1, 2, or 4 screens (multiple screen page length reduces maximum number of possible telnet sessions)
Cursor	Blink or steady, block or underline
Modes	Full duplex, half duplex, block mode, half block mode
Color modes	16 foreground and 16 background colors
Communication Ports	
Serial port for host connection	One DB9M RS232 port
Network port	One RJ45 10Base-T Ethernet port
Local printer ports	One DB25F Parallel and one DB9M RS232 port
Serial baud rates	50 to 115,200 bps
Data format	7 or 8 data bits with or without parity, 1 or 2 stop bits
Serial handshake	XON/XOFF, XPC, and hardware DTR
Communications options	Single RS232 server connection, or up to 12 Ethernet telnet sessions to predefined IP addresses. Both serial and Ethernet connections can not be used concurrently.
Regulatory Approvals	
	CE, RoHS

TROUBLESHOOTING

Each and every piece of every product produced by Network Technologies Inc is 100% tested to exacting specifications. We make every effort to insure trouble-free installation and operation of our products. If problems are experienced while installing this product, please look over the troubleshooting chart below to see if perhaps we can answer any questions that arise. If the answer is not found in the chart, please check the FAQs (Frequently Asked Questions) at our website at <http://www.networktechinc.com> or contact us directly for help at 1-800-742-8324 (800-RGB-TECH) in US & Canada or 1-330-562-7070 worldwide. We will be happy to assist in any way we can.

Problem/Message	Cause	Solution
"OUT OF FREQUENCY"	Input signal is outside the supported range	Lower video frequency to be within specified range
"POWER SAVER MODE"	The input signal is not present. This message will disappear after 5 seconds.	Check all cable connections- verify that they are secure
"NO SIGNAL"	The input signal is not present immediately after power ON.	Check all cable connections- verify that they are secure
"AUTO CONFIGURATION"	The LCD monitor is configuring itself for proper communication with the CPU.	No action is necessary.
Keys pressed on the keyboard do not yield the expected result	"Fn" function is locked ON.	Check to see if the Fn LED is illuminated. If so, press the "Fn" key to unlock the function.
LCD is not displaying image	<ul style="list-style-type: none"> Image out of range LCD Auto-Shut OFF button is depressed LCD is powered OFF 	<ul style="list-style-type: none"> Lower the resolution Make sure nothing is resting on the button Turn power to LCD ON

INDEX

- | | |
|--|--|
| <ul style="list-style-type: none"> ASCII commands, 18 baud rate, 10 Configuration-default, 8 crossover cable, 6, 46 DC power supply, 47 dimensional drawings, 48 Ethernet communication, 12 Ethernet Mode, 10 FAQ, 49 Fn key, 43 Function key, 43 function keys, 11 gateway, 12 glass shield, 2 IP address, 12 keyboard functions, 43 Local keyboard commands, 16 LPD printing, 38 | <ul style="list-style-type: none"> LPD protocol, 37 Materials Supplied, 2 null modem cable, 6 Number Pad, 44 numeric keypad, 45 OSD Controls, 40 OSD Menu, 40 OSD Setup menu, 42 print jobs, 37 printer server, 37 Rack mounting, 4 Setup mode, 7 Technical Specifications, 50 Telco mount, 5 TFTP printing, 39 TFTP protocol, 37 VEXT-1.5-MM, 6 VT100,VT220, 29 |
|--|--|

WARRANTY INFORMATION

The warranty period on this product (parts and labor) is two (2) years from the date of purchase. Please contact Network Technologies Inc at **(800) 742-8324** (800-RGB-TECH) or **(330) 562-7070** or visit our website at <http://www.networktechinc.com> for information regarding repairs and/or returns. A return authorization number is required for all repairs/returns.