



**NETWORK
TECHNOLOGIES
INCORPORATED**

1275 Danner Dr Tel:330-562-7070
Aurora, OH 44202 Fax:330-562-1999
www.networktechinc.com

UNIMUX™ Series

UNIMUX-DVI-2

2-Port USB DVI KVM Switch

Installation and Operation Manual



TRADEMARK

UNIMUX is a trademark of Network Technologies Inc in the U.S. and other countries.

COPYRIGHT

© 2005, 2009 Network Technologies Inc. All rights reserved. No part of this publication may be reproduced, stored in a retrieval system, or transmitted, in any form or by any means, electronic, mechanical, photocopying, recording, or otherwise, without the prior written consent of Network Technologies Inc, 1275 Danner Drive, Aurora, Ohio 44202.

CHANGES

The material in this guide is for information only and is subject to change without notice. Network Technologies Inc reserves the right to make changes in the product design without reservation and without notification to its users.

TABLE OF CONTENTS

INTRODUCTION	1
MATERIALS	1
FEATURES AND FUNCTIONS.....	2
INSTALLATION	3
Connect The Cables	3
Power Up Sequence.....	5
Limitations.....	5
USING THE NTI SWITCH.....	6
CPU Select	6
Keyboard Control.....	6
Command Mode	7
Scan Mode.....	8
Broadcast Mode.....	8
Normal Mode	8
Mice and Trackballs with MACs	8
KEYBOARD FEATURES	9
Keyboard-To-Computer Translation	9
Translation Capabilities	9
Translation Tables	9
International Sun Keyboards	10
TROUBLESHOOTING	11
INDEX.....	12
WARRANTY INFORMATION.....	12

TABLE OF FIGURES

Figure 1- Connect the keyboard, mouse, and AC adapter.....	3
Figure 2- Connect a DVI enabled monitor.....	3
Figure 3- Connect CPU cables	4
Figure 4- Compatible device combinations	5
Figure 5- Flashing LED means CPU is being scanned	8
Figure 6- Keyboard types.....	10

INTRODUCTION

The UNIMUX-DVI-2 USB DVI KVM switch (UNIMUX) allows one user to access two USB CPUs with only one USB keyboard, USB mouse, and a DVI video-enabled monitor. Internal microprocessors allow both CPUs to boot simultaneously and error-free. Port selection is accomplished by a front panel push button or commands typed on the keyboard.

Types of User Input Devices Supported:

- USB keyboard with Windows® layout
- USB keyboard with SUN layout
- USB keyboard with MAC layout with mouse
- USB Mouse - (up to 3 buttons)
- USB IntelliMouse® (scrollwheel)
- NTI USB-Sun Adapter
- USB Hub
- Microsoft, Logitech, and Kensington mice/trackballs

Types of CPUs Supported:

Any USB CPU supporting USB version 1.0 or above including:

- USB WINxx
- USB MAC
- USB SUN

Note: *UNIMUX-DVI-2 is fully compliant with USB standards (1.0, 1.1)*

OPTION: UNIMUX-DVI-2-NBSC – USB DVI KVM switch with no Command, Broadcast, or Scan modes

MATERIALS

Materials Supplied with this kit:

- NTI UNIMUX-DVI-2 Switch
- 120V at 60Hz-5VDC/0.5A AC Adapter (Domestic Only) **OR** 120/240V at 50/60Hz -5VDC/2.0A AC Adapter (Foreign or Domestic)
- Line Cord, country specific (only supplied when 120/240V AC adapter is supplied)

Materials Not Supplied, BUT REQUIRED:

A set of 2 cables for each USB CPU being connected to the switch must be used:

- DVI-IS-xx-MM for monitor interface
- USB-AB-xM for device (keyboard and mouse) interface.

Legend:

xx is the length of the cable in feet

M is an abbreviation for meters

MM indicates male-to-male connector

Cables can be purchased from Network Technologies Inc by calling **(800) 742-8324 (800-RGB-TECH)** in the US and Canada or **(330) 562-7070 (worldwide)**.

Front View of UNIMUX-DVI-2

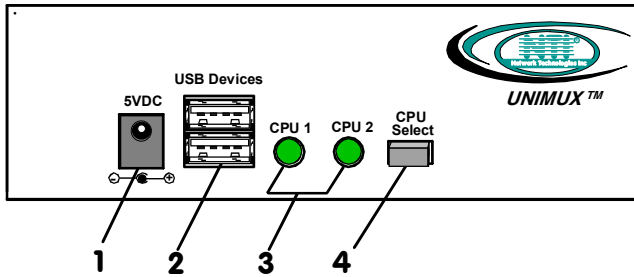

Rear View of UNIMUX-DVI-2

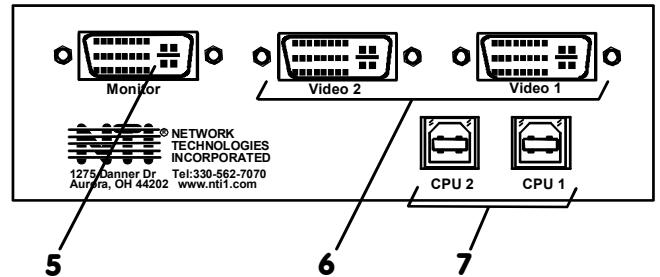

FEATURES AND FUNCTIONS

1. **5VDC**- connection jack for the AC adapter
2. **USB DEVICES**- USB type A female connectors- for connection of user USB device(s)
3. **CPU Status/Mode LEDs**- for visual indication of switch connection between the user and a specific CPU as well as mode status
4. **CPU Select Switch**- push to manually switch to a specific CPU or to change the switch operating mode
5. **MONITOR**- for connection of the user DVI-enabled video monitor
6. **VIDEO x**- female DVI connectors- for connecting DVI cables from CPUs
7. **CPU x**- USB type B female connectors-for connection of USB device cables from CPUs

INSTALLATION

Connect The Cables

1. It is not necessary to turn OFF power to either of the CPUs that will be connected to the UNIMUX before connecting or disconnecting any cables.
NOTE: If a CPU needs to identify a keyboard, it will be necessary to power ON the CPU after it is connected to the UNIMUX and only after the keyboard is connected and the UNIMUX is powered ON.
2. Connect a USB keyboard to a female USB type A port labeled "USB DEVICES" on the UNIMUX. See Fig. 1.
3. Connect a USB mouse to the other female USB type A port labeled "USB DEVICES" on the UNIMUX.
4. Connect the AC adapter to the port labeled "5VDC".

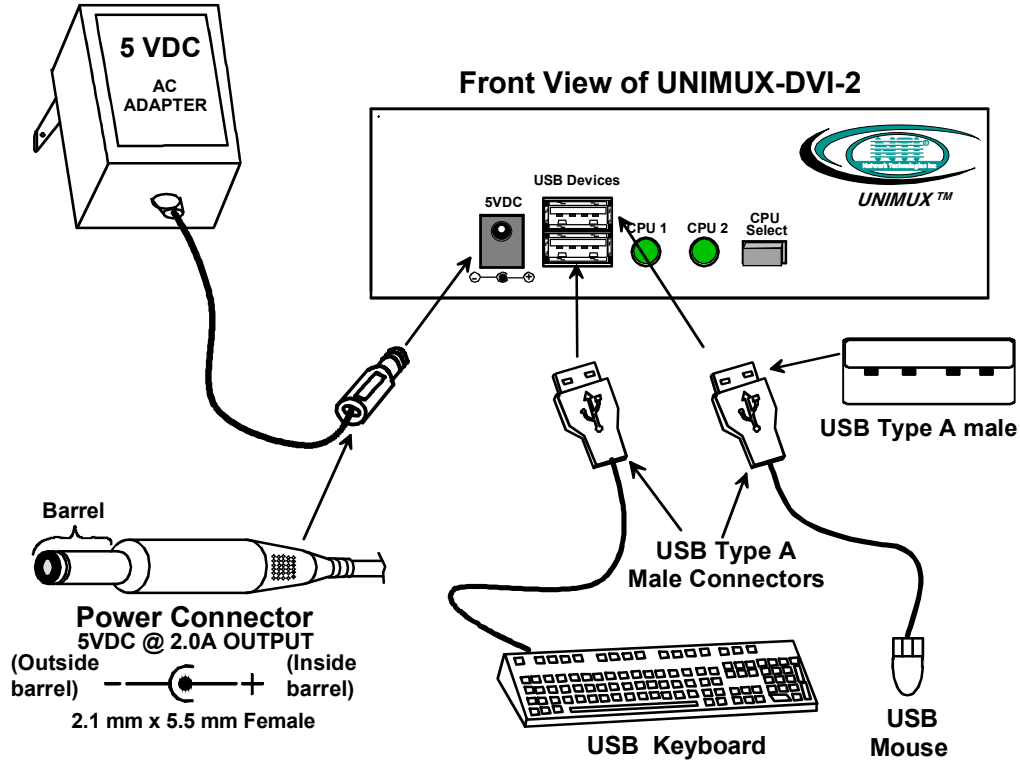

Figure 1- Connect the keyboard, mouse, and AC adapter

5. Connect a DVI-enabled monitor to the female DVI port labeled "MONITOR" on the UNIMUX. Be sure to tighten the two screws on the monitor cable connector to the UNIMUX securely.

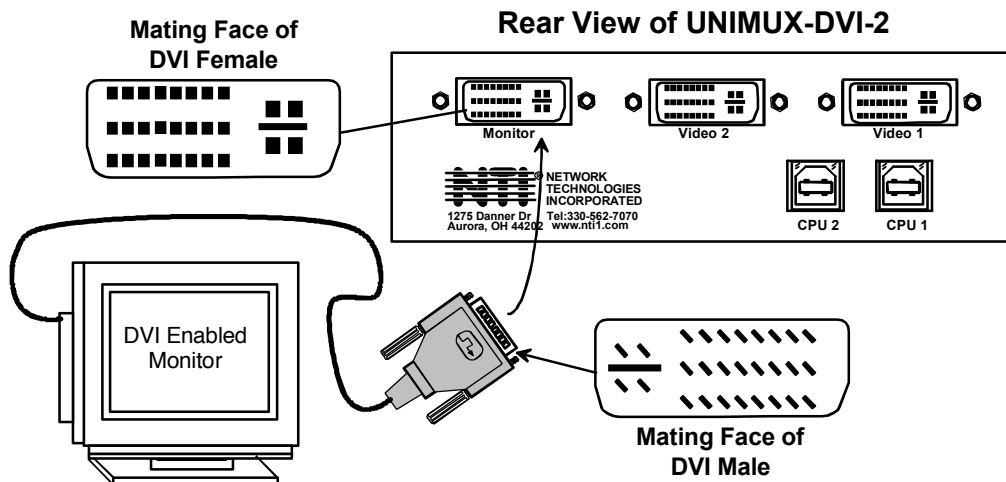

Figure 2- Connect a DVI enabled monitor

6. Using a USB-AB-x-MM cable connect the USB type A device port of a USB CPU to the USB type B port labeled "CPU 1" on the UNIMUX.
7. Using a DVI-IS-xx-MM connect the DVI video port of the same USB CPU connected in step 5 to the female DVI port labeled "VIDEO 1" on the UNIMUX. Be sure to tighten the two screws on the cable connector to the UNIMUX securely.
8. Repeat steps 6 and 7 for connecting a second USB CPU to the ports labeled "CPU 2" and "VIDEO 2" . See Fig. 3.

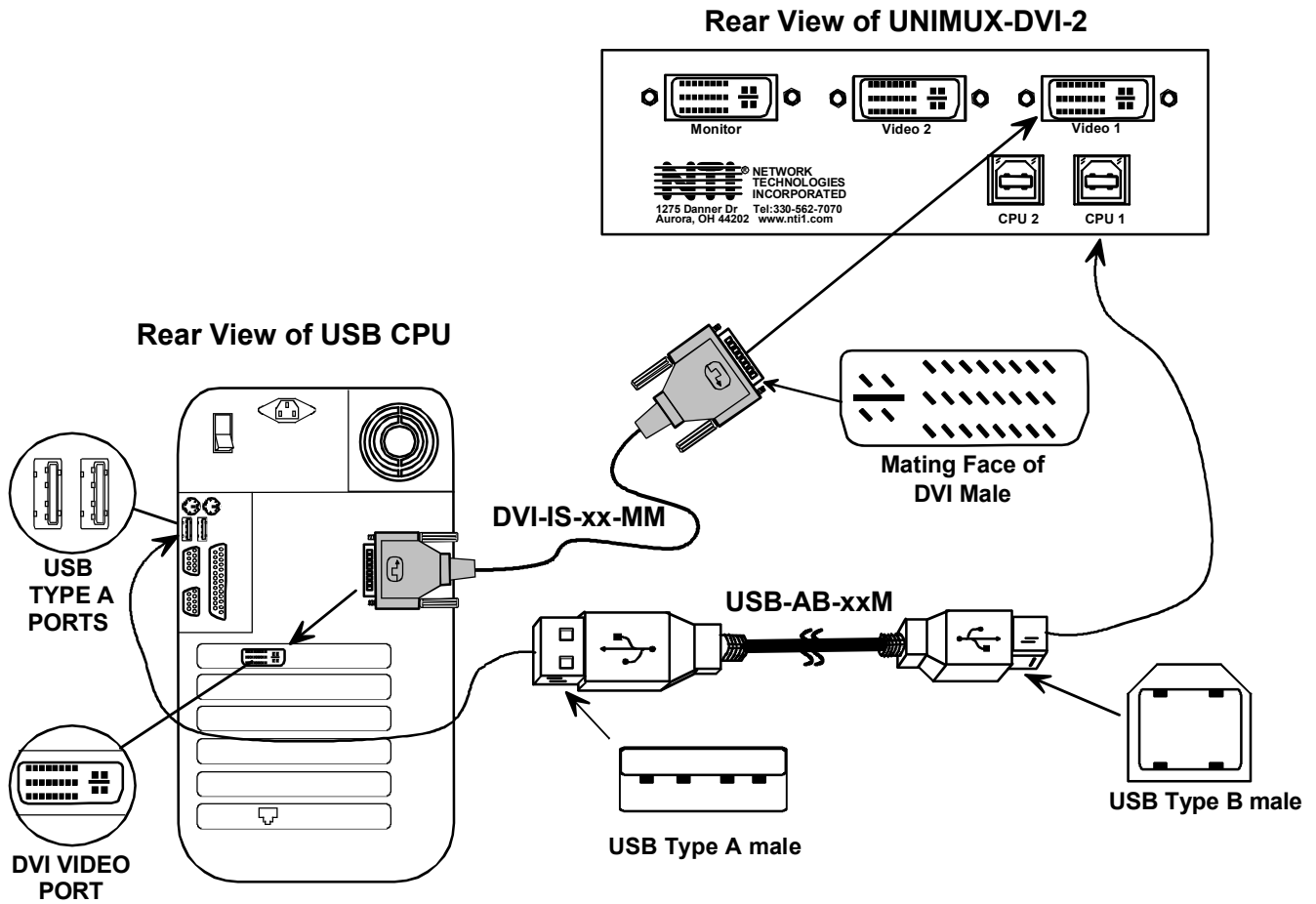

Figure 3- Connect CPU cables

Power Up Sequence

The UNIMUX can be powered at any time. The CPUs can be powered at any time although if a CPU needs a keyboard and/or mouse at power-ON it should be powered after connecting to and powering-ON the UNIMUX. USB devices (keyboard and mouse) can be hot plugged to and from the UNIMUX at any time. Remember, the last device attached is the active one.

Limitations

- Only USB input device or hub cables can be connected to the UNIMUX at the USB Type A female ports labeled "USB DEVICES". (See Features and Functions on page 2, item 2.)
- A USB hub (single or multi-port) can be used provided only USB input devices are plugged into it.
- Only a USB Windows or SUN keyboard or USB mouse may be connected to the USB port on a USB MAC keyboard
- A maximum of 8 input devices may be connected to the UNIMUX either directly or through hubs.

See Fig. 4 for some examples of input device combinations that can be used with the UNIMUX.

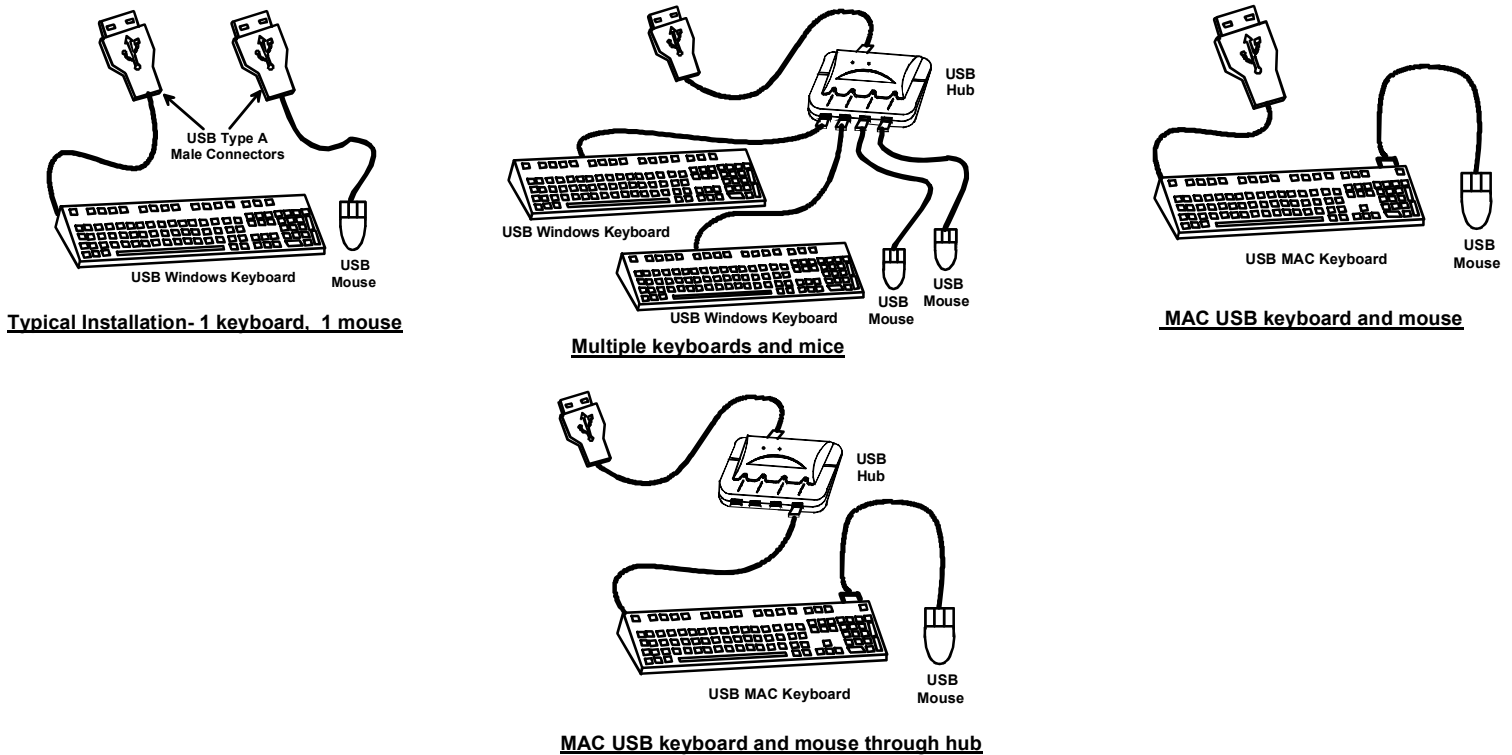

Figure 4- Compatible device combinations

USING THE NTI SWITCH

The NTI UNIMUX-DVI-2 can be operated by the CPU SELECT button on the side of the switch or by keyboard control.

CPU Select

- Pressing the CPU SELECT button on the UNIMUX will toggle between CPU 1 and CPU 2 which connects the selected CPU to the user's keyboard, monitor, and mouse.
- Holding down the CPU SELECT button for more than 2 seconds will cause the UNIMUX to cycle through all modes of operation: COMMAND, SCAN, BROADCAST, and NORMAL (see pages 6 and 7 for Command, Scan, Broadcast, and Normal mode sections). After the first change, modes will continue to change every 2 seconds as long as the CPU SELECT button is still pressed in. The CPUx LEDs will indicate which mode the switch is in (see the table below). Release the button when the desired mode has been selected.

NOTE: On model UNIMUX-DVI-2-NBSC, the CPU SELECT button will only toggle between CPU1 and CPU2. Command, Scan, and Broadcast modes are not available.

Switch Mode Indication

MODE	CPUx LED INDICATION
COMMAND	Both LEDs illuminated
SCAN	One LED flashing
BROADCAST	Both LEDs flashing alternately
NORMAL	One LED illuminated solid

Keyboard Control

In order to control the other features of the switch with the keyboard, Command Mode must be enabled. To enter Command Mode from the keyboard:

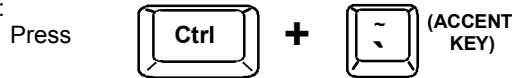

When the Command Mode is enabled, all 3 status lights on the keyboard will illuminate and both LEDs on the UNIMUX will illuminate solid to indicate Command Mode is enabled and the following functions are available: **(NOTE: The user must exit Command Mode in order to use the CPU(s) in the selected mode. To exit Command Mode, press ESC on the keyboard.)** The mouse will not operate while in Command Mode.

NOTE: While in Command Mode, when a proper programming key is pressed and recognized by the switch, the LEDs on the keyboard will flash once to indicate acceptance. The user must exit Command Mode (by pressing ESC) to see a change take effect in the switch operation.

























NOTE: The UNIMUX will automatically exit Command Mode after 10 seconds of inactivity by the user if the user does not manually exit Command Mode.

NOTE: Command Mode not available on model UNIMUX-DVI-2-NBSC.

Command Mode

Function:

Keystroke:

Increment Port	 or  (select the next higher port ex. 01 → 02)	KEY SYMBOLS LEGEND: OR PRESS EITHER KEY + CHORDED SEQUENCE- PRESS CONSECUTIVELY AND KEEP KEYS PRESSED UNTIL ALL ARE PRESSED. - PRESS CONSECUTIVELY
Decrement Port	 or  (select the next lower port ex. 02 → 01)	
Toggle Scan Mode ON and OFF	 (When toggled to ON, Scan Mode will be indicated the LED for only the active CPU flashing ON and OFF .)	
Sets scan time-out period for each port.	 -  -  -  (xxx from 002 to 255. ie. t002 would set the time-out period for 2 seconds)	
Toggle Broadcast Mode ON and OFF	 (When toggled to ON, Broadcast Mode will be indicated by both LEDs cycling alternately ON and OFF in rapid intervals.)	
Selects a specific port	 -  -  (P0x would be P01 or P02.)	
Select a different control key combination	 -  x = the desired key (This will replace the Ctrl + ` sequence to enter Command Mode)	
Select a specific country code for the keyboard	 -  -  (Lxx would be L00-L34, see Country Codes Table on page 11)	
Print the code version to a text editor	 (This will print the version of the code in the UNIMUX to a text editor window for use when troubleshooting the switch)	
Configure port to connect To a MAC CPU	 +  (x= 1 or 2 <M> + <1> will enable function on Port 1 <M> + <2> will enable function on Port 2. Keyboard LED's will flash once to confirm command.)	
Configure port to connect To a WINDOWS or SUN CPU	 +  (x= 1 or 2 <W> + <1> will disable function on Port 1 <W> + <2> will disable function on Port 2. Keyboard LED's will flash once to confirm command.)	
Exit Command Mode		Note: The user must exit Command Mode to use the CPU(s) in the selected mode.

Default Value Reset

Default factory-set values for Command Mode entry key, Scan dwell time and country code can be restored by following this procedure:

1. Disconnect power from the UNIMUX
2. Press and hold the CPU SELECT button on the switch
3. Re-connect power to the switch
4. Release the CPU SELECT button

NOTE: Command Mode not available on model UNIMUX-DVI-2-NBSC.

Scan Mode

Scan Mode is indicated by a flashing CPU port LED. In Scan Mode the switch scans back and forth between ports making the CPU connected to the port with the flashing LED active. That connected port will remain active while in use. When the connected port becomes idle for the user selected time out period (default time is 5 seconds), the UNIMUX will connect to the other CPU port. See Command Mode section on page 7 for configuring the scan time out period.

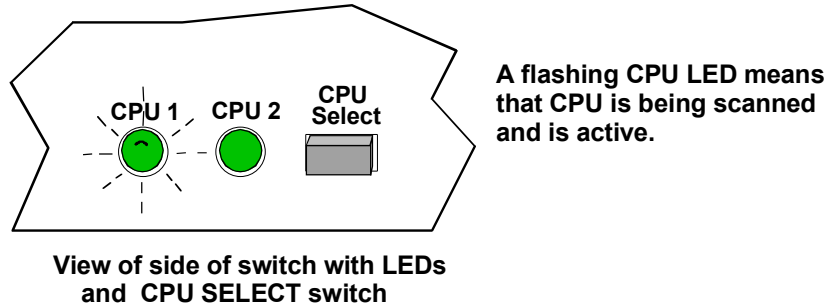

Figure 5- Flashing LED means CPU is being scanned

NOTE: The keyboard and mouse must remain idle for the full scan time out period before the UNIMUX will connect to the other port.

NOTE: Scan Mode not available on model UNIMUX-DVI-2-NBSC.

Broadcast Mode

(use with extreme caution)

Broadcast Mode allows the user to send keystrokes to all active CPUs. Broadcast Mode is indicated by illuminating the CPU x LEDs in rapid alternating intervals. Broadcast Mode has some critical requirements:

- Broadcast Mode must be OFF when booting any attached CPUs.
- Broadcast Mode must be ON and the user must exit Command Mode for keystrokes to reach attached CPUs.

NOTE: The mouse is disabled leaving only the keyboard active during Broadcast Mode.

NOTE: Broadcast Mode not available on model UNIMUX-DVI-2-NBSC.

Normal Mode

The UNIMUX is in Normal Mode when only the LED for the active CPU is illuminated solid (not flashing as in Scan Mode). When in Normal Mode, the user is controlling only the CPU to which the user is connected through the UNIMUX. In Normal Mode the UNIMUX will only switch between CPUs 1 and 2 when the user uses either keyboard control or button control to do so.

Mice and Trackballs with MACs

The UNIMUX can be configured to enable full functionality between mice and trackballs having two or more buttons and USB MAC CPUs. By default, the ports on the UNIMUX are configured for use with WINDOWS and SUN CPUs and have no special translation for using multi-function mice and trackballs when a MAC CPU is connected. Using the commands in Command Mode on page 6, either enable or disable this feature as needed for each port.

NOTE: Be sure to re-configure port for connection to a WINDOWS or SUN CPU if a MAC CPU is removed and a WINDOWS or SUN CPU is then connected.

KEYBOARD FEATURES

The keyboard configuration of each CPU is saved in the UNIMUX. For example, if the CPU attached to Port 2 had CAPS LOCK and NUM LOCK selected the last time that CPU was accessed, then they will automatically be set when that CPU is accessed again.

Keyboard-To-Computer Translation (See Fig. 6 on page 10 for reference.)

The UNIMUX enables a mixture of otherwise incompatible peripheral computer components to be connected together. This is accomplished by performing keyboard-to-computer translations automatically (i.e. translate a MAC keyboard and mouse to a Windows type CPU). The chart below shows the capabilities of devices controlling certain CPU types.

Translation Capabilities

Device	CPU		
	Sun	Mac	Windows
Sun Keyboard	Full functionality	Full functionality	Full functionality
AT101 Keyboard	Extra keys emulation	Power key emulation	Full functionality
Mac keyboard	Extra keys emulation	Full functionality	Full functionality-except Application Key
Apple Pro Keyboard	Extra keys emulation	Extra Keys not supported (Eject, Mute, Volume+, Volume-)	Full functionality
Sun Mouse	Full functionality	Full functionality	Full functionality
Wheel Mouse	Full functionality	Full functionality	Full functionality
Apple Mouse	Right button emulation	Full functionality	Right button emulation

Translation Tables

Use the chart below to type SUN's additional keys with Win95 and Apple keyboards:

WINxx or Mac Keyboards	Sun Extra Keys
Space Bar + F1	Stop
Space Bar + F2	Again
Space Bar + F3	Props
Space Bar + F4	Undo
Space Bar + F5	Front
Space Bar + F6	Copy
Space Bar + F7	Open
Space Bar + F8	Paste
Space Bar + F9	Find
Space Bar + F10	Cut
Space Bar + F11	Help
Space Bar + F12	Compose
Space Bar + Up Arrow	Volume +
Space Bar + Down Arrow	Volume -
Space Bar + Left Arrow	Mute

Power Key Emulation		
Win95 Keyboards	Mac CPU	Sun CPU
SB+RT Arrow	Power	Power

Mouse Click Equivalents

To emulate right-button click using an Apple 1-button mouse, hold down the CMND key (key with open apple insignia) while pressing the mouse button.

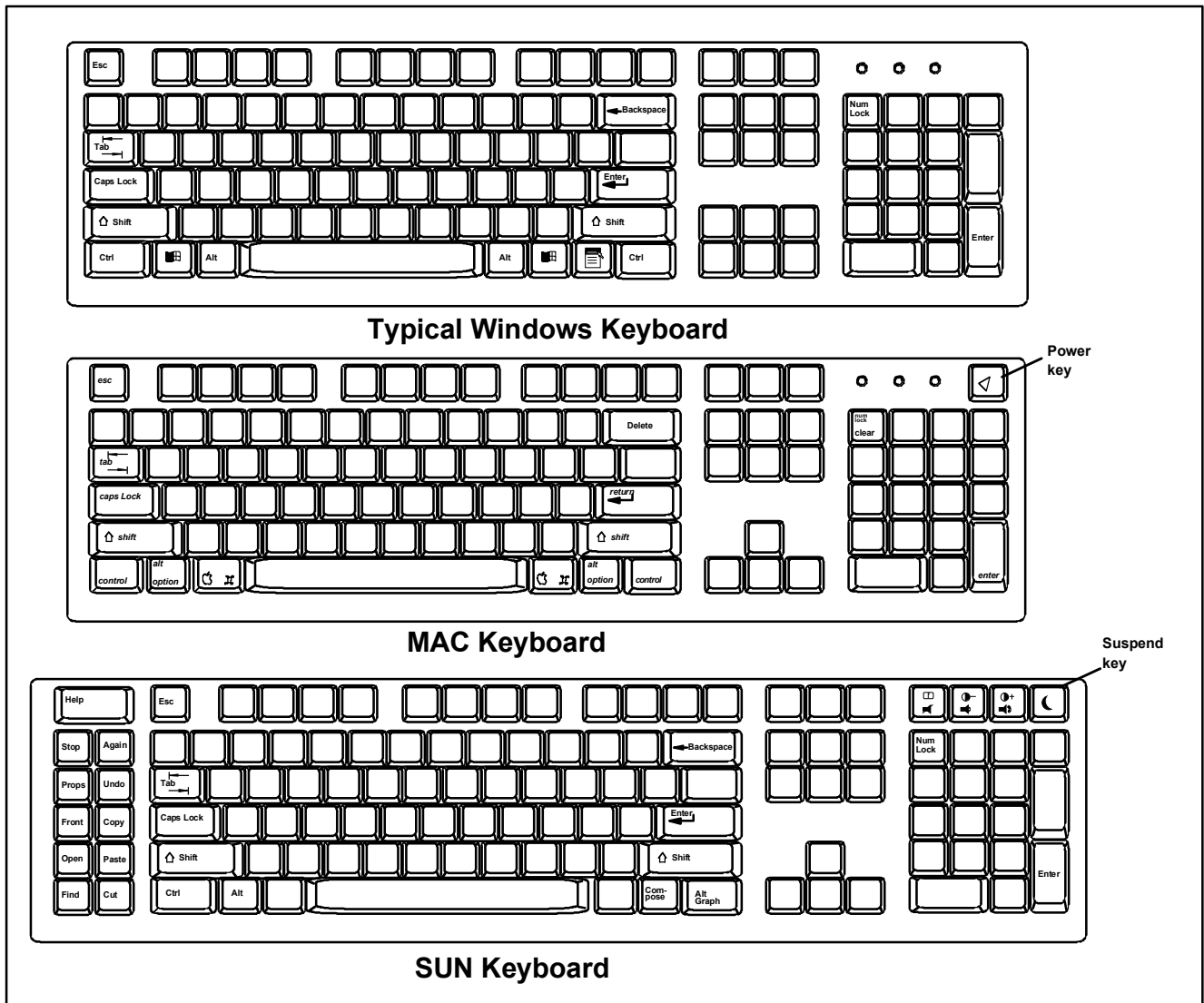

Figure 6- Keyboard types

International Sun Keyboards

The UNIMUX can recognize international layouts for Sun keyboards. In order to use an international Sun keyboard, follow this procedure:

1. Disconnect the CPU from the UNIMUX
2. Connect the international keyboard to be used to the UNIMUX
3. Disconnect power to the UNIMUX for at least 3 seconds
4. Reconnect power to the UNIMUX
5. Reconnect the CPU to the UNIMUX

It is also possible to configure the UNIMUX to emulate a specific international Sun keyboard regardless of what actual keyboard is connected. This is recommended when the CPU needs the layout code (i.e. a SUN CPU) and the keyboard doesn't have an explicit layout code (i.e. some Windows keyboards). To do this, manually set the UNIMUX to indicate the international keyboard identification number to the CPU using the following procedure;

1. Connect the keyboard to be used to the UNIMUX
2. Disconnect power from the UNIMUX for at least 3 seconds
3. Reconnect power to the UNIMUX
4. Enter Command Mode
5. Type Lxx, where xx is the number from the list below that corresponds to the desired country code
6. Exit Command Mode
7. Disconnect power from the UNIMUX for at least 3 seconds
8. Reconnect power to the UNIMUX
9. Reboot the CPU connected to the UNIMUX.

Country Codes

00	Not Supported	18	Netherlands/Dutch
01	Arabic	19	Norwegian
02	Belgian	20	Persian (Farsi)
03	Canadian-Bilingual	21	Poland
04	Canadian-French	22	Portuguese
05	Czech Republic	23	Russia
06	Danish	24	Slovakia
07	Finnish	25	Spanish
08	French	26	Swedish
09	German	27	Swiss/French
10	Greek	28	Swiss/German
11	Hebrew	29	Switzerland
12	Hungary	30	Taiwan
13	International (ISO)	31	Turkish
14	Italian	32	UK
15	Japan (Katakana)	33	US
16	Korean	34	Yugoslavia
17	Latin American	35-99	Reserved

TROUBLESHOOTING

1. Verify all cables are securely connected and that the installation procedure was carefully followed.
2. If a CPU seems to be locked up,
 - cycle the power to the UNIMUX OFF, then ON.
 - unplug the "USB DEVICES" keyboard and mouse cables (not the "CPU x" keyboard and mouse) from the UNIMUX and reconnect them.
 - reset default values as described on page 7.
 - reboot the CPU

If the UNIMUX still seems work improperly, help may be found in the Frequently Ask Questions (FAQ's) section of our website at <http://www.netwoktechinc.com> or call us directly at **(800) 742-8324 (800-RGB-TECH)** or **(330) 562-7070** and we will be happy to assist in any way we can.

INDEX

Broadcast Mode, 8	MAC CPUs, 8
cables required-not supplied, 1	materials supplied, 1
Command Mode, 7	Normal Mode, 8
country codes, 11	Scan Mode, 8
CPUs supported, 1	Sun International Keyboards, 10
devices supported, 1	Toubleshooting, 11
keyboard control, 6	USB hub, 5
keyboard translations, 9	USB-AB-x-MM, 4

WARRANTY INFORMATION

The warranty period on this product (parts and labor) is two (2) years from the date of purchase. Please contact Network Technologies Inc at **(800) 742-8324** (800-RGB-TECH) or **(330) 562-7070** or visit our website at <http://www.networktechinc.com> for information regarding repairs and/or returns. A return authorization number is required for all repairs/returns.

MODEL NO: UNIMUX-DVI-2

SERIAL NO.: _____

DATE: _____

INSPECTED BY: _____