

(Customer Spec)

# NTI P/N: VKMEXT-15-MM-V2

Page 1 of 2

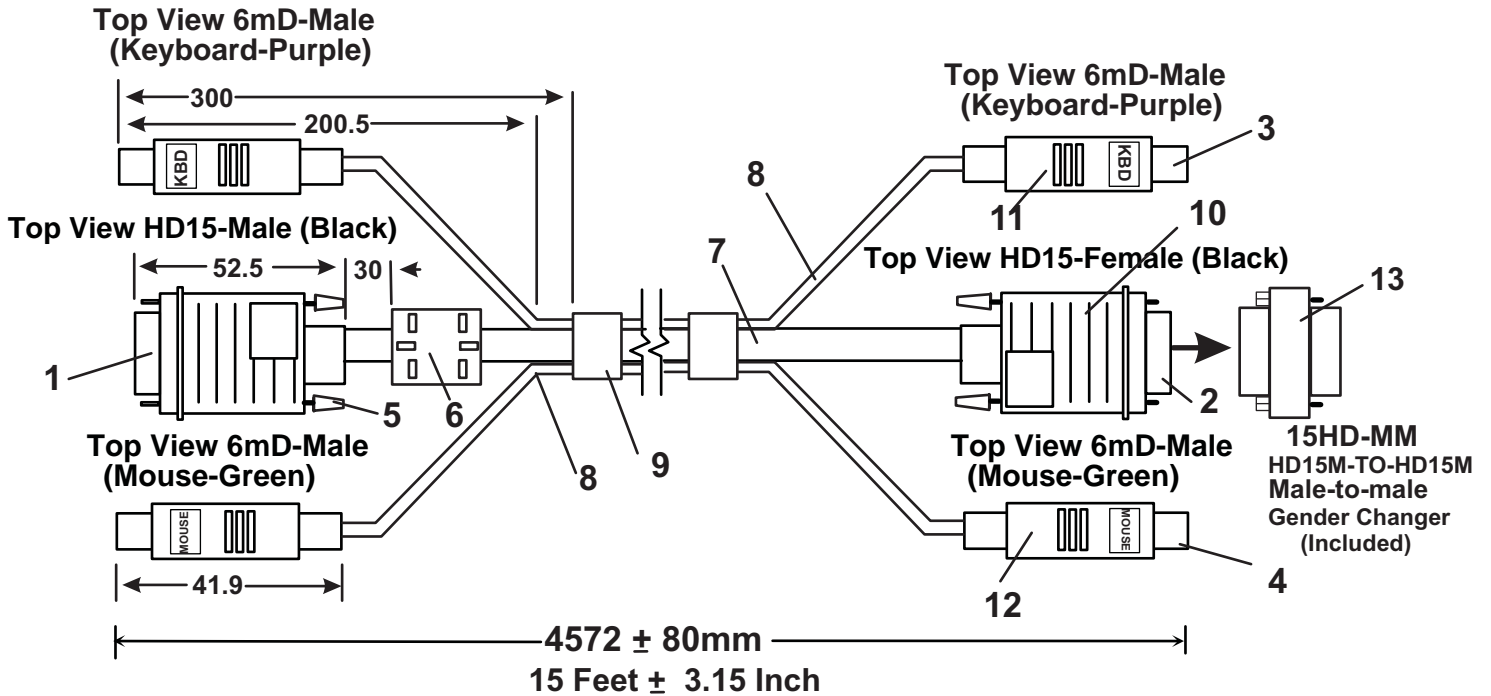

No.	Description
1	HD15 MALE WITHOUT PIN 9, GOLD FLASH ON CONTACTS
2	HD15 FEMALE, GOLD FLASH ON CONTACTS
3	MINI DIN 6 MALE, GOLD FLASH ON CONTACTS, PURPLE INSULATOR
4	MINI DIN 6 MALE, GOLD FLASH ON CONTACTS, GREEN INSULATOR
5	MOLDED THUMBSCREW #4-40, 48mm LONG, BLACK
6	FERRITE CORE, 14.3x6.35x28.5MM, BLACK
7	3F CABLE, UL2919 3 MINI COAXIAL CABLE 32AWG AND 4 X 30AWG TWISTED PAIRS, ALUM-MYLAR FOIL AND COPPER BRAIDED SHIELDING WITH DRAIN WIRE, OD 5.5mm, BLACK JACKET
8	UL2464 6C 30AWG ALUM-MYLAR FOIL AND COPPER BRAIDED SHIELDING WITH DRAIN WIRE, OD 3.0MM, JACKET BLACK
9	MOLDED PVC BLACK
10	MOLDE PE (TRANSPARENT) AND PVC (BLACK)
11	MOLDE PE (TRANSPARENT) AND PVC (PURPLE)
12	MOLDE PE (TRANSPARENT) AND PVC (GREEN)
13	15HD MALE-TO-MALE FULLY SHIELDED CONNECTOR (INCLUDED)



# NTI P/N: VKMEXT-15-MM-V2

## Mating Face of HD15 Male

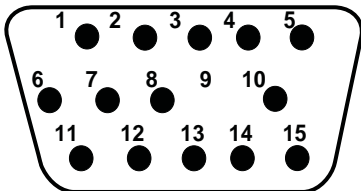

PIN 9 IS NOT USED IN HD15 CONNECTORS

## Mating Face of HD15 Female

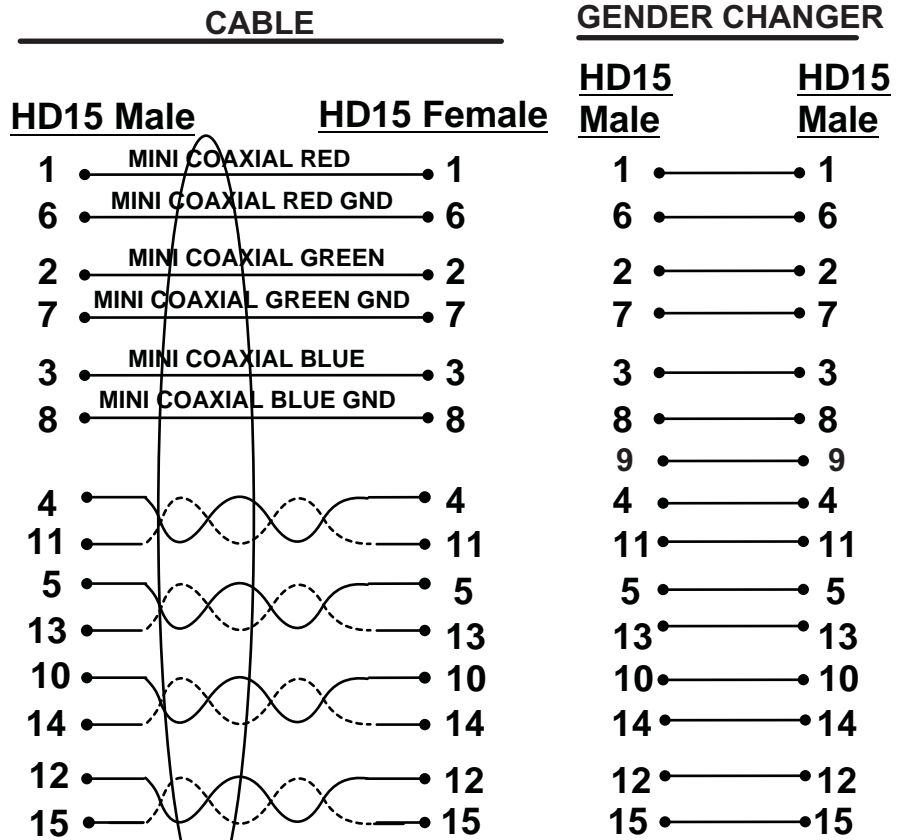
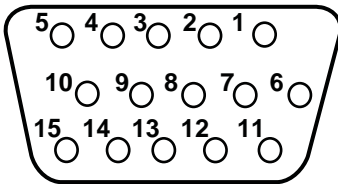

SHELL

SHELL

METALIZED MYLAR FOIL AND COPPER BRAIDED SHIELD WITH 30AWG DRAIN WIRE

## KEYBOARD-Male

## KEYBOARD-Male

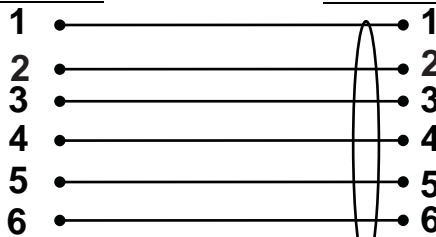

SHELL

SHELL

METALIZED MYLAR FOIL AND COPPER BRAIDED SHIELD WITH 30AWG DRAIN WIRE

## MOUSE-Male

## MOUSE-Male

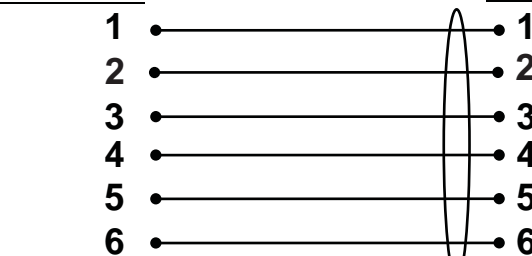

SHELL

SHELL

METALIZED MYLAR FOIL AND COPPER BRAIDED SHIELD WITH 30AWG DRAIN WIRE

THE DRAIN WIRE OF EACH CABLE SHIELD IS CONNECTED TO THE METAL SHELL AT EACH END OF EACH CABLE

## Mating Face of 6 miniDIN Male

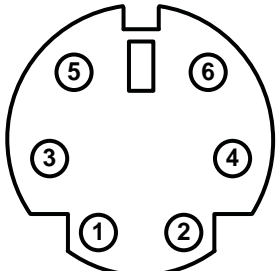

KEYBOARD AND MOUSE CONNECTORS ARE ALL 6 PIN miniDIN